



L225SRB-M

- Application** Interior directional light for wall, picture or signage illumination.
- IP Rating** 20
- Mounting** Retrofit to existing standard octagonal box using custom mounting plate.
* See installation sheet.
- Electrical** 4W / 8W
- Power Supply** Powered by remote dimmable/ non-dimmable driver (sold separately).
*Consult factory for dimming options
- Power Consumption** 4.0 Watt
8.0 Watt
- Light Output** 4.0 Watt, 224~261lm
8.0 Watt, 372~433lm
- Warranty** 5 years limited warranty
Estimated useful life of LED is 50,000 hours.
- Material** Solid anodized aluminum . RoHS compliant.
- Weight** -
- Approval** 

Type:

Project:

Modified:

Quantity:

Notes:

Dimension:

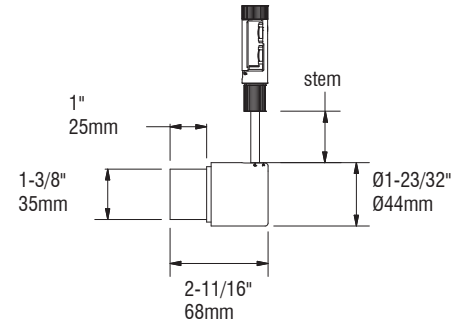

Order Guide

Example: L225-SRB-M-8-W27H-S-NA-2-MA

Code	Mount	Size	Wattage	Color	Beam	Accessories	Accessory Finish	Stem	Finish
L225	SRB	M	-	-	-	FS	-	-	BA
	SRB = single rail track	M = medium	4 = 4W 8 = 8W	W27H = 2700K, 90+CRI W30H = 3000K, 90+CRI	S = spot (19°) N = narrow flood (27°) F = flood (48°)	FS = full shroud	MA = matte clear anodized BA = black anodized	2 = 2" (51mm) X = custom	BA = black anodized

* Available in 1" (25mm) increments up to 8ft (2.4m) max.

PHOTOMETRIC DATA:

4W, 2700K 90+CRI, 19°

Polar Candela Distribution

Illuminance at a Distance

Lumen: 261 lm

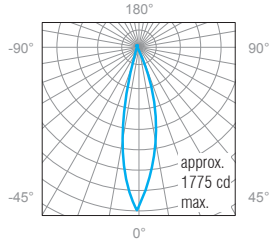

	Center Beam FC	Beam Width
3.0'	197	1.0'
6.0'	49.3	2.1'
9.0'	21.9	3.1'
12'	12.3	4.1'
15'	7.89	5.2'
18'	5.48	6.2'

0° Spread: 19.5°

8W, 2700K 90+CRI, 19°

Polar Candela Distribution

Illuminance at a Distance

Lumen: 433 lm

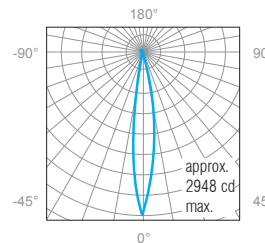

	Center Beam FC	Beam Width
3.0'	328	1.0'
6.0'	81.9	2.1'
9.0'	36.4	3.1'
12'	20.5	4.1'
15'	13.1	5.2'
18'	9.10	6.2'

0° Spread: 19.5°

4W, 2700K 90+CRI, 27°

Polar Candela Distribution

Illuminance at a Distance

Lumen: 251 lm

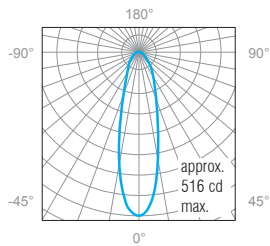

	Center Beam FC	Beam Width
3.0'	57.4	1.4'
6.0'	14.3	2.9'
9.0'	6.38	4.3'
12'	3.59	5.7'
15'	2.30	7.2'
18'	1.59	8.6'

0° Spread: 26.9°

8W, 2700K 90+CRI, 27°

Polar Candela Distribution

Illuminance at a Distance

Lumen: 418 lm

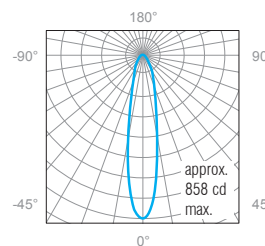

	Center Beam FC	Beam Width
3.0'	95.3	1.4' (426mm)
6.0'	23.8	2.9' (883mm)
9.0'	10.6	4.3' (1.31m)
12'	5.95	5.7' (1.74m)
15'	3.81	7.2' (2.19m)
18'	2.65	8.6' (2.62m)

0° Spread: 26.9°

4W, 2700K 90+CRI, 48°

Polar Candela Distribution

Illuminance at a Distance

Lumen: 224 lm

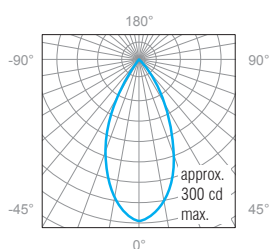

	Center Beam FC	Beam Width
3.0'	33.4	2.6
6.0'	8.34	5.3'
9.0'	3.71	7.9'
12'	2.09	10.6'
15'	1.33	13.2'
18'	0.93	15.9'

0° Spread: 47.6°

8W, 2700K 90+CRI, 48°

Polar Candela Distribution

Illuminance at a Distance

Lumen: 372 lm

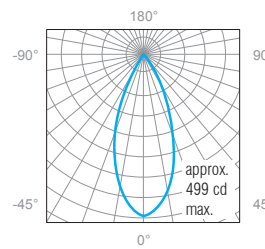

	Center Beam FC	Beam Width
3.0'	55.4	2.6
6.0'	13.9	5.3'
9.0'	6.16	7.9'
12'	3.46	10.6'
15'	2.22	13.2'
18'	1.54	15.9'

0° Spread: 47.6°