

# L60013

**Application** Exterior/Interior pendant

**IP Rating** 42

**Mounting** Mounts to standard 4" octagonal box comes with standard 72" (1829mm) field adjustable coaxial cable or 6" (152mm) stem. Longer custom length available.

**Electrical** 13.0W driver (standard)  
13.0W driver (Halogen Dim)  
Integral driver (standard) input: 120AC (dimnable with Triac, 0-10V or non-dimmable), 277V AC (non-dimmable)  
Remote driver (standard) input: 120V AC or 277V AC (dimnable with Triac, 0-10V, DMX, DALI or non-dimmable), 277V AC (non-dimmable).  
*\*Optional remote drivers and back up power supplies available. Consult factory.*

**Power Consumption** 13.0 Watt (standard)  
13.0 Watt ( Halogen Dim)

**Light Output** 13.0 Watt, 1044~1080lm  
*\*For photometric data, see page 03*

**Warranty** 5 years limited warranty  
Estimated useful life of LED is 50,000 hours.

**Material** Anodized aluminum. RoHS compliant

**Weight** 2lbs (0.907kg)

**Approval** 

**Emergency Driver options(remote)** MP Lighting Emergency Backup Unit.  
Input: 100-277V, 50/60Hz Output: 11-36V, 16W  
  
Bodine Emergency Micro Inverter  
Input: 120/277V, 50/60HZ Output: 120/277V, 60Hz, 20W

**Type:**

**Project:**

**Modified:**

**Quantity:**

**Notes:**

## Order Guide

Example: L600-C13-13-W30-S-F-S-1-S6-MA

Code	Canopy	Wattage	Color	CRI	Beam	Reflector Color	Input Voltage	Cord/stem	Finish
<b>L600</b>	<b>C13</b>	<b>- 13</b>							
	<b>C13</b> = Ø4-5/8" (116mm) x 1-5/6" (48mm)	<b>13</b> = 13W	<b>W27</b> = 2700K <b>W30</b> = 3000K <b>W35</b> = 3500K <b>HG</b> = halogen dim (2000K~2800K)	<b>S</b> = 80+ std CRI <b>V</b> = 97+ CRI <i>*97+ CRI only available for W27/W30</i>	<b>S</b> = spot (10°) <b>N</b> = narrow flood (30°) <b>F</b> = flood (40°)	(see below)	<b>1</b> = 120V <b>2</b> = 277V  <i>** Input Voltage</i> <i>1 = 120V Input integral driver. Phase dimmable.</i> <i>2 = 120-277V Universal input voltage. 0-10V dimmable.</i>	<b>S6</b> = 6" (152mm) stem <b>SX</b> = custom stem* <b>C72</b> = 72" (1829mm) cord <b>CX</b> = custom cord  <i>* available in 1" increments up to 8ft max.</i>	<b>MA</b> = matte clear anodized <b>BA</b> = black anodized <b>BZ</b> = bronze anodized <b>WH</b> = white powder coating
				<i>Option</i>					
				<b>BZ</b> = bronze specular <b>S</b> = silver specular <b>B</b> = black specular					

**DIMENSION:**

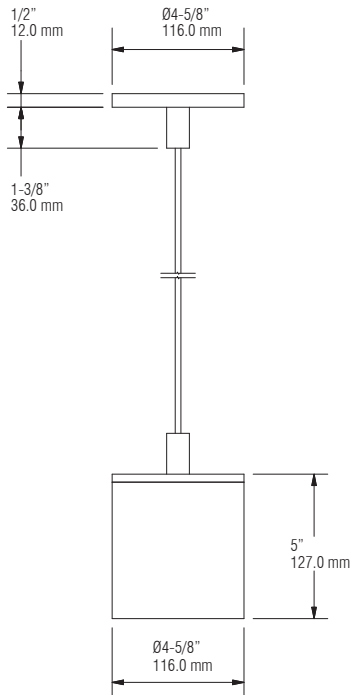

**LIGHT DISTRIBUTION:**

13WATT

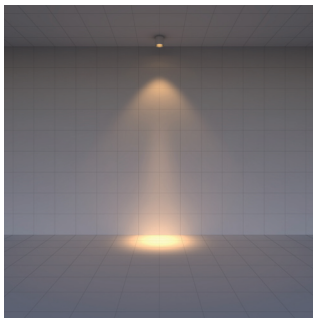

10° (Spot beam)  
Matte clear anodized

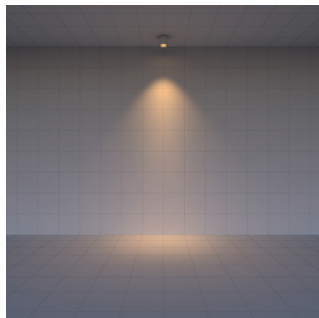

30° (Narrow Flood beam)  
Matte clear anodized

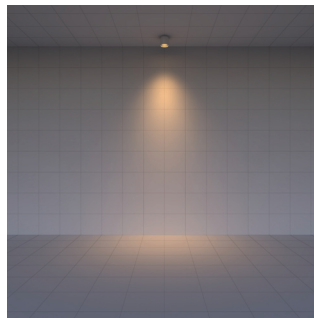

40° (Flood beam)  
Matte clear anodized

**PHOTOMETRIC DATA:**

**13W 3000K 80+CRI**

**Polar Candela Distribution**

**Illuminance at a Distance**

**Lumen: 1050lm, Spot (10°)**

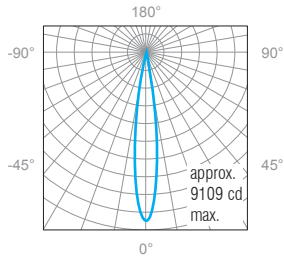

	Center Beam FC	Beam Width
3.0'	1012.1	0.8'
6.0'	253.0	1.6'
9.0'	112.5	2.5'
12.0'	63.3	3.1'
15.0'	40.5	3.9'
18.0'	28.1	4.7'

0° Spread: 14.8°

**Lumen: 1044lm, Narrow flood (30°)**

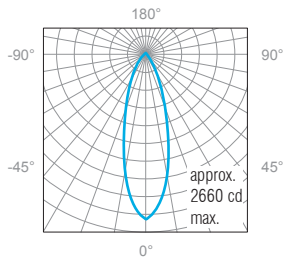

	Center Beam FC	Beam Width
3.0'	295.6	1.6'
6.0'	73.9	3.3'
9.0'	32.8	4.9'
12.0'	18.5	6.6'
15.0'	11.8	8.2'
18.0'	8.2	9.8'

0° Spread: 30.5°

**Lumen: 1080lm, Flood (40°)**

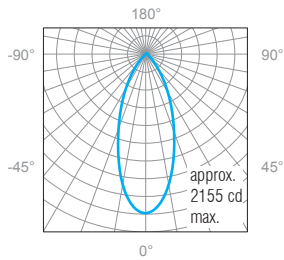

	Center Beam FC	Beam Width
3.0'	239.4	2.1'
6.0'	59.8	4.2'
9.0'	26.6	6.3'
12.0'	15.0	8.4'
15.0'	9.6	10.5'
18.0'	6.6	12.6'

0° Spread: 38.6°