

Shown as wall hook 23" (584mm) curved stem.

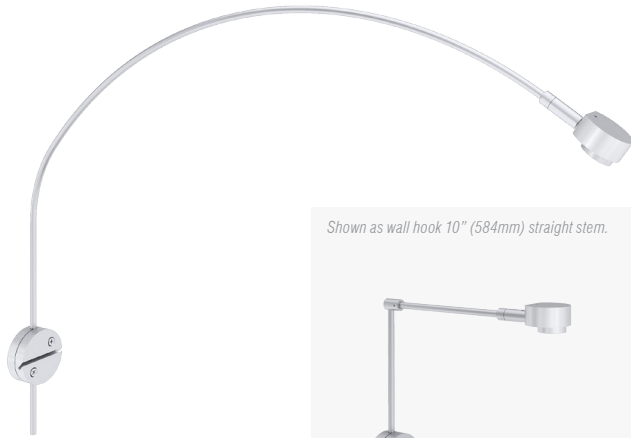

Shown as wall hook 10" (584mm) straight stem.

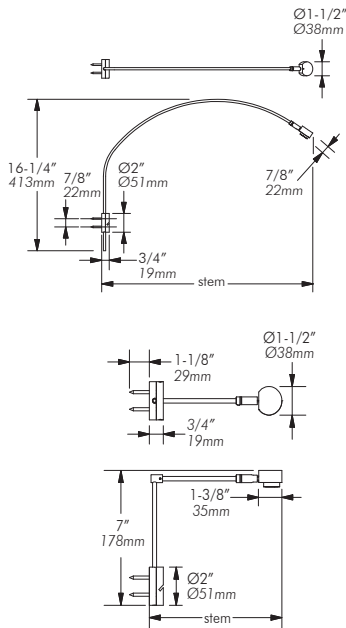

1W / 2.5W Picture Light

L81WK

SPEC SHEET

Application: Indoor picture or millwork illumination.

Electrical: 1W, 350mA or 2.5W, 700mA LED. Powered by remote 120V or 277V primary, 350mA (1W) or 700mA (2.5W) driver (not included).

LED Input Voltage: 4V DC

Power Consumption: 1.5W / 3W

Recommended Driver: LED8W350L (1W) or LED17W700D (2.5W).

Dimmable drivers available (not included). Consult factory.

Weight: 0.86lbs (0.392kg) with S5 straight stem.

Material: Plated brass. RoHS compliant.

Mounting: Wall mounts to 2" (51mm) wall hook.

Approval: Dry locations. Approved to US and Canadian standards by CSA.



Type:

Project:

Modified:

Quantity:

Notes: PLEASE READ - When using a control system, consult dimming system manufacturer with minimum load before installing 12V AC transformer. Malfunction and damage to product due to improper dimming system installation or misuse will not be covered under warranty. Only DC Drivers are recommended for dimming systems. Consult MP Lighting for recommended drivers.

Order Guide

Example: L81-WK-1-W27S-S-S5-MC

| CODE | MOUNT | WATTAGE | COLOR | BEAM | STEM | FINISH |
|------|----------------|--------------------|--|---|--|-------------------|
| L81 | WK | - | | | - | |
| | WK = wall hook | 1 = 1W 2 = 2.5W | W22S = 2200K, 80+CRI W27S = 2700K, 80+CRI W30S = 3000K, 80+CRI W35S = 3500K, 80+CRI W41S = 4100K, 80+CRI W30H = 3000K, 90+CRI | S = spot (12°) N = narrow flood (30°) W = wide flood (120°) | S5 = 5" (127mm) straight stem S10 = 10" (254mm) straight stem SX = custom straight stem C10 = 10" (254mm) curved stem C23 = 23" (584mm) curved stem CX = custom curved stem | MC = matte chrome |

Note: Standard CRI has a value of 75~82 while high CRI has 92.

MP LIGHTING

t 1.877.708.1184 f 604.708.1185 www.mplighting.com
16 West 4th Avenue, Vancouver BC V5Y 1G3, Canada

L81WK

SPEC SHEET

Lumen test results provided
by LED chip manufacturer

Photometric Data

L81
1W, 12°
3000K Std
85 lm

Polar Candela Distribution

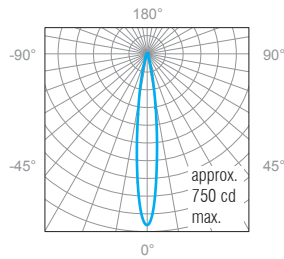

Illuminance at a Distance

| | Center Beam FC | Beam Width |
|------|----------------|------------|
| 0.3' | 6,846.22 | 0.1' 0.1' |
| 0.7' | 1,711.56 | 0.2' 0.2' |
| 1.0' | 760.67 | 0.2' 0.3' |
| 1.3' | 427.89 | 0.3' 0.3' |
| 1.7' | 273.85 | 0.4' 0.4' |
| 2.0' | 190.17 | 0.5' 0.5' |

0° Spread: 13.8° 90° Spread: 14.9°

L81
1W, 30°
3000K Std
85 lm

Polar Candela Distribution

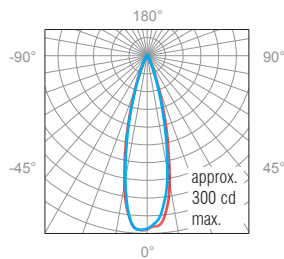

Illuminance at a Distance

| | Center Beam FC | Beam Width |
|------|----------------|------------|
| 0.3' | 2,632.25 | 0.2' 0.2' |
| 0.7' | 658.06 | 0.3' 0.3' |
| 1.0' | 292.47 | 0.5' 0.5' |
| 1.3' | 164.52 | 0.6' 0.7' |
| 1.7' | 105.29 | 0.8' 0.8' |
| 2.0' | 73.12 | 0.9' 1.0' |

0° Spread: 25.5° 90° Spread: 27.5°

L81
1W, 120°
3000K Std
85 lm

Polar Candela Distribution

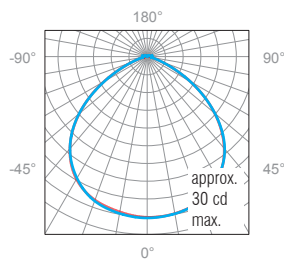

Illuminance at a Distance

| | Center Beam FC | Beam Width |
|------|----------------|------------|
| 0.3' | 278.73 | 0.9' 0.8' |
| 0.7' | 69.68 | 1.7' 1.7' |
| 1.0' | 30.97 | 2.6' 2.5' |
| 1.3' | 17.42 | 3.4' 3.4' |
| 1.7' | 11.15 | 4.3' 4.2' |
| 2.0' | 7.74 | 5.1' 5.0' |

0° Spread: 103.9° 90° Spread: 103.0°

L81
2.5W, 12°
3000K Std
162 lm

Polar Candela Distribution

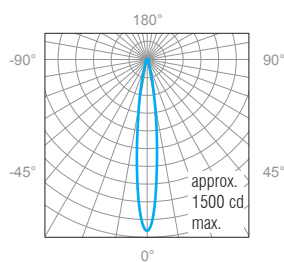

Illuminance at a Distance

| | Center Beam FC | Beam Width |
|------|----------------|------------|
| 0.3' | 13,048 | 0.1' 0.1' |
| 0.7' | 3,262 | 0.2' 0.2' |
| 1.0' | 1,450 | 0.2' 0.3' |
| 1.3' | 815.51 | 0.3' 0.3' |
| 1.7' | 521.92 | 0.4' 0.4' |
| 2.0' | 362.45 | 0.5' 0.5' |

0° Spread: 13.8° 90° Spread: 14.9°



t 1.877.708.1184 f 604.708.1185 www.mplighting.com
16 West 4th Avenue, Vancouver BC V5Y 1G3, Canada

Note: Various operating factors may cause differences between lab and field results. As specifications may change without notice, please refer to the LED Lamp Index located in the "Downloads" section of each product webpage for the most current information.

L81WK

SPEC SHEET

Lumen test results provided
by LED chip manufacturer

Photometric Data

L81
2.5W, 30°
3000K Std
162 lm

Polar Candela Distribution

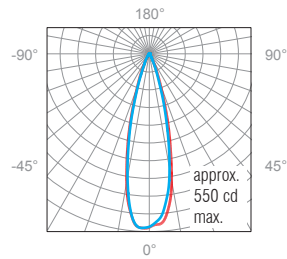

Illuminance at a Distance

| | Center Beam FC | Beam Width | |
|------|----------------|------------|------|
| 0.3' | 5,017 | 0.2' | 0.2' |
| 0.7' | 1,254 | 0.3' | 0.3' |
| 1.0' | 557.42 | 0.5' | 0.5' |
| 1.3' | 313.55 | 0.6' | 0.7' |
| 1.7' | 200.67 | 0.8' | 0.8' |
| 2.0' | 139.35 | 0.9' | 1.0' |

0° Spread: 25.5° 90° Spread: 27.5°

L81
2.5W, 120°
3000K Std
162 lm

Polar Candela Distribution

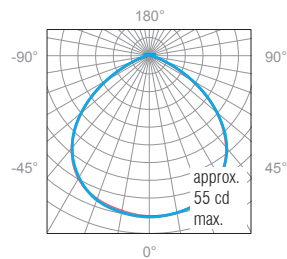

Illuminance at a Distance

| | Center Beam FC | Beam Width | |
|------|----------------|------------|------|
| 0.3' | 490.51 | 0.9' | 0.8' |
| 0.7' | 122.63 | 1.7' | 1.7' |
| 1.0' | 54.50 | 2.6' | 2.5' |
| 1.3' | 30.66 | 3.4' | 3.4' |
| 1.7' | 19.62 | 4.3' | 4.2' |
| 2.0' | 13.63 | 5.1' | 5.1' |

0° Spread: 104 90° Spread: 103.5°