

Canopy Mount

H30C4

SPEC SHEET



Application: Accent, decorative, general and down lighting.

Electrical: Ceramic metal halide (not included).

Input Current: 0.18A (22W), 0.33A (39W)
 Input Voltage: 120V AC
 Power Consumption: 22W, 39W

Weight: 1.942lbs (0.881kg)

Material: Machined aluminum body.

Mounting: Mounts to standard J-box (not included).

Lamp (not included): BT5.

Average rated life: 12,000 hrs
 Average initial lumens: 1650 (22W), 2400 (39W)
 CRI: 90
 CCT (k): 3000 °



Approval: Dry locations. Approved to UL standards by CSA/US.



Type:

Project:

Modified:

Quantity:

Notes: PLEASE READ - When using a control system, consult dimming system manufacturer with minimum load before installing 12V AC transformer. Malfunction and damage to product due to improper dimming system installation or misuse will not be covered under warranty. Only DC Drivers are recommended for dimming systems. Consult MP Lighting for recommended drivers.

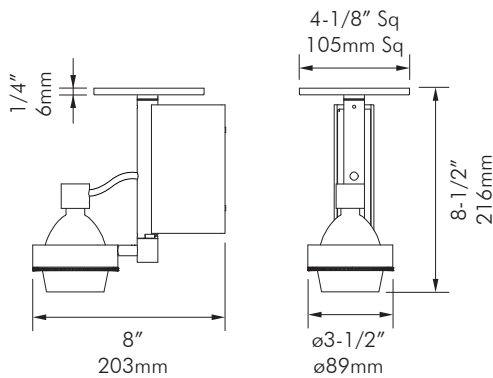

Order Guide

Example: H30-C4-BT5-22-15-BK

CODE	MOUNTING	LAMP	WATTAGE	BEAM	FINISH
H30	C4	BT5			
	C4 = C4 Canopy Mount		22 = 22W 39 = 39W	15 = 15° Beam 30 = 30° Beam	BK = Black S = Silver

Note: Fixture comes with Shroud, but can be used without it.



t 604.708.1184 f 604.708.1185 www.mplighting.com
 16 West 4th Avenue, Vancouver BC V5Y 1G3, Canada

Canopy Mount
H30C4
 SPEC SHEET

Photometric Data

