

# L114T

## INTERIOR

Linear | For shelves, cabinets & display cases

● Dry location

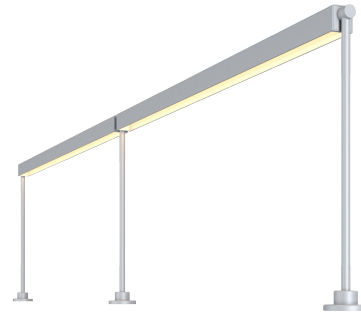

### Ordering Information

Clear Form

Date : \_\_\_\_\_

Quantity : \_\_\_\_\_

Project : \_\_\_\_\_

Note : \_\_\_\_\_

Type : \_\_\_\_\_

### Specifications

Luminaire | Example Code: L114T-2-MB-4-4-W30H-W-P-6-MA

Product	Version	Mounting <sup>1</sup>	Section Length 1 <sup>2</sup>	Section Length 2 <sup>2</sup>	CCT & CRI	Beam Angle	Lens	Stem <sup>4</sup>	Finish
L114T									MA
	2 2W/ft 6 6W/ft	MB mounting bracket C22 canopy mount	1' 1ft * <b>Minimum</b> X custom 4' 4ft * <b>Maximum</b> <sup>3</sup>	1' 1ft * <b>Minimum</b> X custom 4' 4ft * <b>Maximum</b> <sup>3</sup>	<b>N (30°) &amp; F (60°) beam:</b> W27H 2700K 90+ W30H 3000K 90+  <b>W (120°) beam:</b> W22S 2200K 80+ W27H 2700K 90+ W30H 3000K 90+ W35H 3500K 90+ W41H 4100K 90+	N narrow 30° F flood 60° W wide 120°	F frosted P prismatic	6 6" (152mm) 12 12"(305mm) X custom	MA matte clear anodized

### System Components (Ordered Separately)

Remote Driver : \_\_\_\_\_

Control System : \_\_\_\_\_

On/Off | Dimming ELV or 0-10 dimming  
Other options (consult factory) TRIAC/MLV, DMX, DALI, Casambi, PoE

### Important Notes

#### Specification

- J-Box required for installations using the C22 canopy option.
- Minimum: 1' (305mm) Maximum: 4' (1219mm), 6" (152.4mm) increments.
- 4' comes with 3 ft. 1/4" (1200mm) LED board/section length
- Minimum: 2.5" (63.5mm) Maximum: 4' (1219mm), 1" (25.4mm) increments.

#### Warranty Notes & Disclaimer

Malfunction and damage to product due to incompatible dimming system or misuse will not be covered under warranty. Consult MP Lighting for recommended drivers. If the fixture has an option to be installed with a dimming control system, consult a dimming system manufacturer with minimum load before installing. MP Lighting reserves the right, at its sole discretion, at any time and without notice, to make design changes to any of our products. Consult MP Lighting website for most updated documentation.

# L114T

## INTERIOR

Linear | For shelves, cabinets & display cases

● Dry location

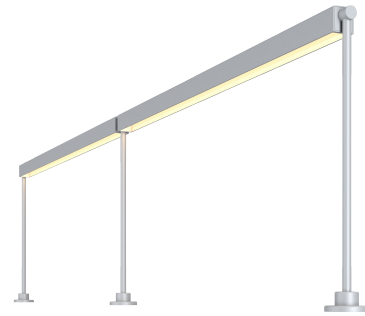

### Performance

Wattage	Forward Current	Power Consumption Budget per fixture (including driver)	LED output (Source)	Fixture Output (Delivered)
2W/ft	84mA	2.5W/ft	220 lm/ft	95-119 lm/ft
6W/ft	250mA	7W/ft	660 lm/ft	322-352 lm/ft

### Application

Environment	Dry Location approved. IP 52.
Mounting	<b>Surface-mounted/Recessed:</b> Mounts with stem and mounting brackets or C22 canopy.

### Electrical

Power Supplies	Remote LED drivers (120-277V AC input, <b>constant voltage output</b> ): Fixtures to be wired in parallel. <b>Recommended (consult factory):</b> TLDAV100W24V04iB or TLDAV100W24V05iB
Control	<b>On/off control</b> <b>Dimming:</b> ELV or 0-10V dimming with appropriate drivers <b>Other options (consult factory):</b> TRIAC/MLV, DMX, DALI, Casambi, Power over Ethernet

### Luminaire Construction

LED Light Source	<b>Colour Consistency:</b> 3-step MacAdam
Weight	N/A
Material	<b>Fixture:</b> extruded marine-grade aluminum with polycarbonate lens
Supplied with	<b>Standard installation housing:</b> Comes with stems & mounting brackets and covers.
Warranty & LED Life	5 years limited warranty Estimated useful life of LED is 50,000 hours.

### Ordered Separately

System Components	<b>Power supplies:</b> remote driver Please consult factory or visit <a href="#">Recommended Drivers</a> for available driver options.
-------------------	---

Mounting Options & Dimensions

LED Fixture Dimensions (surface mount shown with mounting brackets)

Fixture

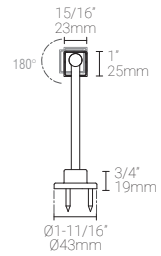

Side View

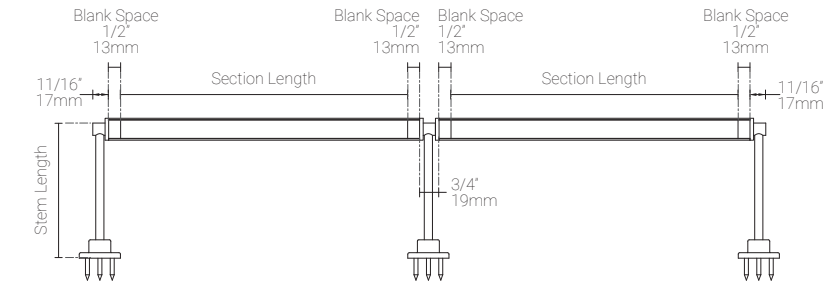

3D View



Recessed mount (shown with mounting brackets)

Fixture

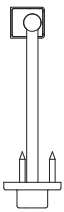

Side View

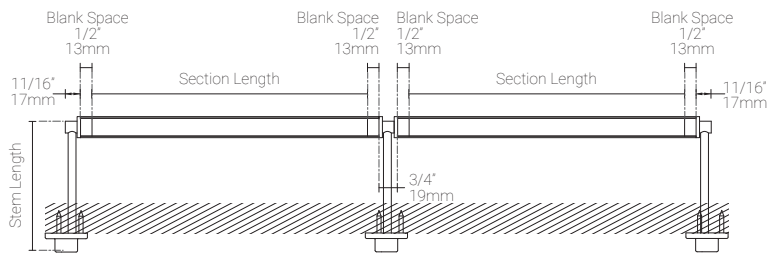

3D View

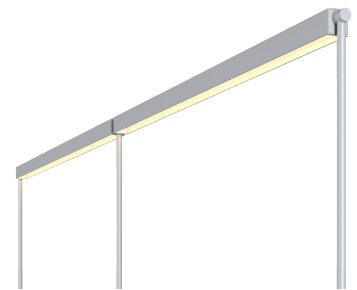

Surface mount (shown with C22)

Fixture

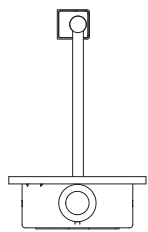

Side View

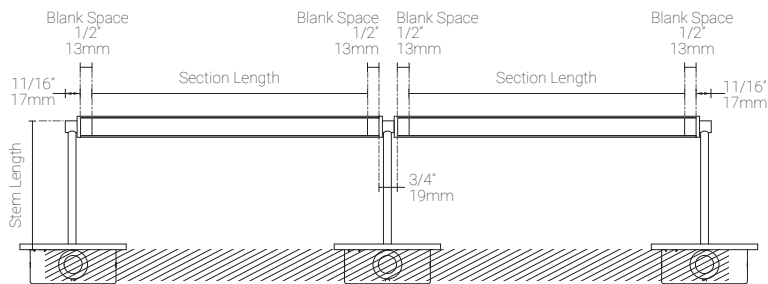

3D View



Fixture head rotation

Shining down

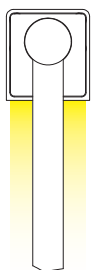

Shining up

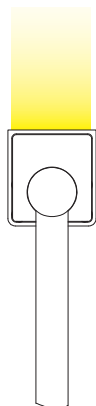

Shining 90°

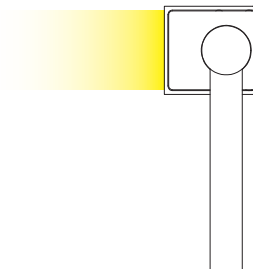

2W, 1' (305mm), 3000K, 90+ CRI, Frosted Lens

Polar Candela Distribution

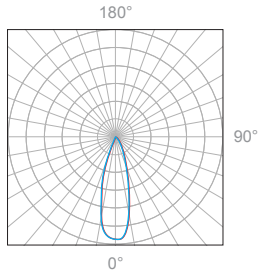

Beam Width: 30°

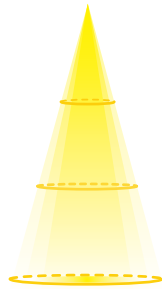

Illuminance at a Distance

Distance		Center Beam fc	Beam Width			
0.5ft	0.15m	145fc	0.3ft	0.09m	0.3ft	0.09m
1.0ft	0.30m	60fc	0.5ft	0.15m	0.5ft	0.15m
2.0ft	0.61m	17fc	1.1ft	0.34m	1.1ft	0.34m
3.0ft	0.91m	7.6fc	1.6ft	0.49m	1.6ft	0.49m
4.0ft	1.22m	4.3fc	2.1ft	0.64m	2.1ft	0.64m

Delivered Lumen: 111.7lm  
 ■ Vertical Beam Spread: 30.4°  
 ■ Horizontal Beam Spread: 30.3°

Polar Candela Distribution

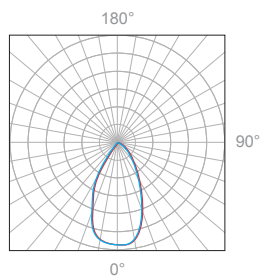

Beam Width: 60°

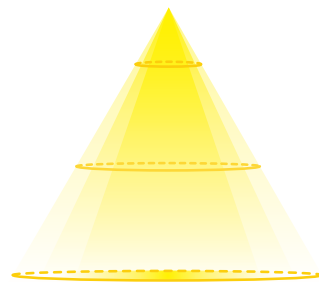

Illuminance at a Distance

Distance		Center Beam fc	Beam Width			
0.5ft	0.15m	139fc	0.5ft	0.15m	0.5ft	0.15m
1.0ft	0.30m	57fc	1.1ft	0.34m	1.1ft	0.34m
2.0ft	0.61m	16fc	2.1ft	0.64m	2.1ft	0.64m
3.0ft	0.91m	7.3fc	3.2ft	0.98m	3.2ft	0.98m
4.0ft	1.22m	4.2fc	4.3ft	1.31m	4.3ft	1.31m

Delivered Lumen: 95.3lm  
 ■ Vertical Beam Spread: 55.9°  
 ■ Horizontal Beam Spread: 56.1°

Polar Candela Distribution

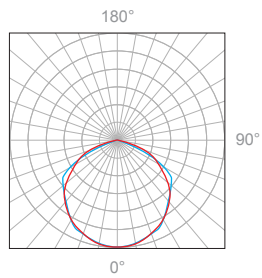

Beam Width: 120°

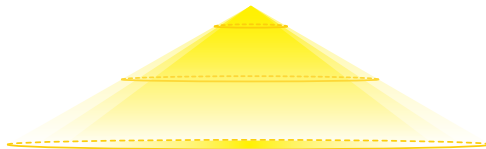

Illuminance at a Distance

Distance		Center Beam fc	Beam Width			
0.5ft	0.15m	134fc	0.9ft	0.27m	1.6ft	0.49m
1.0ft	0.30m	52fc	1.8ft	0.55m	3.2ft	0.98m
2.0ft	0.61m	14fc	3.5ft	1.07m	6.3ft	1.92m
3.0ft	0.91m	6.5fc	5.3ft	1.62m	9.5ft	2.90m
4.0ft	1.22m	3.6fc	7.1ft	2.16m	12.7ft	3.87m

Delivered Lumen: 118.6lm  
 ■ Vertical Beam Spread: 83.3°  
 ■ Horizontal Beam Spread: 115.3°

2W, 1' (305mm), 3000K, 90+ CRI, Prismatic Lens

Polar Candela Distribution

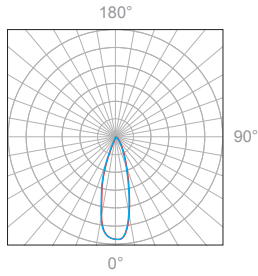

Beam Width: 30°



Illuminance at a Distance

Distance		Center Beam fc	Beam Width			
0.5ft	0.15m	319fc	0.3ft	0.09m	0.3ft	0.09m
1.0ft	0.30m	162fc	0.5ft	0.15m	0.5ft	0.15m
2.0ft	0.61m	57fc	1.1ft	0.34m	1.1ft	0.34m
3.0ft	0.91m	27fc	1.6ft	0.49m	1.6ft	0.49m
4.0ft	1.22m	15fc	2.1ft	0.64m	2.1ft	0.64m

Delivered Lumen: 135.3lm  
 ■ Vertical Beam Spread : 30.4°  
 ■ Horizontal Beam Spread : 30.3°

Polar Candela Distribution

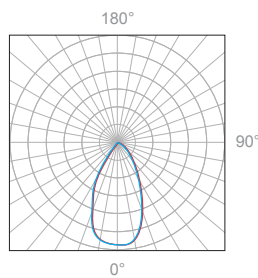

Beam Width: 60°

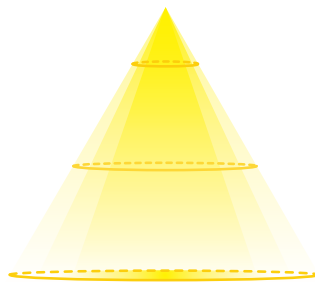

Illuminance at a Distance

Distance		Center Beam fc	Beam Width			
0.5ft	0.15m	323fc	0.5ft	0.15m	0.5ft	0.15m
1.0ft	0.30m	155fc	1.0ft	0.30m	1.0ft	0.30m
2.0ft	0.61m	50fc	2.1ft	0.64m	2.1ft	0.64m
3.0ft	0.91m	22fc	3.1ft	0.94m	3.1ft	0.94m
4.0ft	1.22m	13fc	4.1ft	1.25m	4.1ft	1.25m

Delivered Lumen: 115.9lm  
 ■ Vertical Beam Spread: 55.4°  
 ■ Horizontal Beam Spread: 56.4°

Polar Candela Distribution

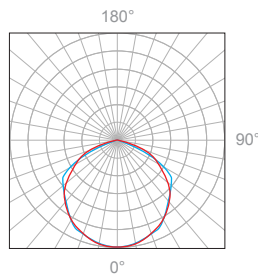

Beam Width: 120°

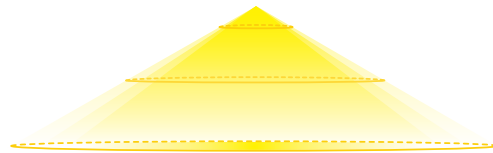

Illuminance at a Distance

Distance		Center Beam fc	Beam Width			
0.5ft	0.15m	205fc	0.9ft	0.27m	1.5ft	0.46m
1.0ft	0.30m	81fc	1.8ft	0.55m	3.0ft	0.91m
2.0ft	0.61m	22fc	3.6ft	1.09m	6.1ft	1.86m
3.0ft	0.91m	10fc	5.4ft	1.65m	9.1ft	2.77m
4.0ft	1.22m	5.7fc	7.2ft	2.19m	12.1ft	3.69m

Delivered Lumen: 138.1lm  
 ■ Vertical Beam Spread: 83.5°  
 ■ Horizontal Beam Spread: 113.2°

6W, 1' (305mm), 3000K, 90+ CRI, Frosted Lens

Polar Candela Distribution

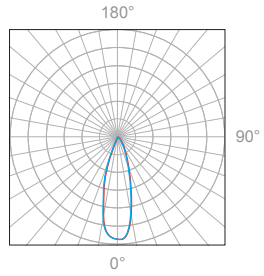

Beam Width: 30°

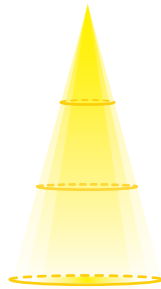

Illuminance at a Distance

Distance		Center Beam fc	Beam Width			
0.5ft	0.15m	519fc	0.3ft	0.09m	0.3ft	0.09m
1.0ft	0.30m	213fc	0.5ft	0.15m	0.5ft	0.15m
2.0ft	0.61m	61fc	1.1ft	0.34m	1.1ft	0.34m
3.0ft	0.91m	27fc	1.6ft	0.49m	1.6ft	0.49m
4.0ft	1.22m	15fc	2.1ft	0.64m	2.1ft	0.64m

Delivered Lumen: 344.2lm  
 ■ Vertical Beam Spread: 30.4°  
 ■ Horizontal Beam Spread: 30.3°

Polar Candela Distribution

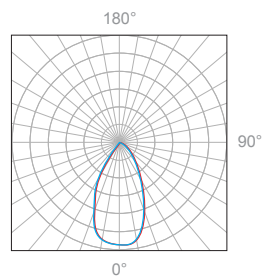

Beam Width: 60°

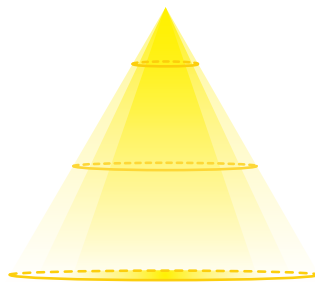

Illuminance at a Distance

Distance		Center Beam fc	Beam Width			
0.5ft	0.15m	466fc	0.5ft	0.15m	0.5ft	0.15m
1.0ft	0.30m	207fc	1.1ft	0.34m	1.1ft	0.34m
2.0ft	0.61m	57fc	2.1ft	0.64m	2.1ft	0.64m
3.0ft	0.91m	26fc	3.2ft	0.98m	3.2ft	0.98m
4.0ft	1.22m	14fc	4.3ft	1.31m	4.3ft	1.31m

Delivered Lumen: 322.7lm  
 ■ Vertical Beam Spread: 55.8°  
 ■ Horizontal Beam Spread: 56.2°

Polar Candela Distribution

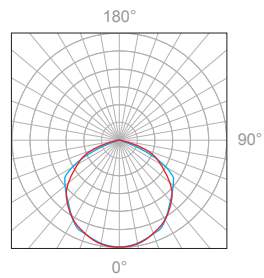

Beam Width: 120°

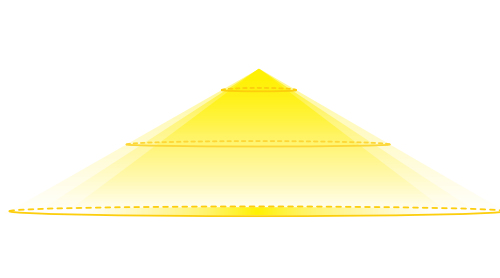

Illuminance at a Distance

Distance		Center Beam fc	Beam Width			
0.5ft	0.15m	458fc	0.9ft	0.27m	1.6ft	0.49m
1.0ft	0.30m	181fc	1.8ft	0.55m	3.2ft	0.98m
2.0ft	0.61m	47fc	3.5ft	1.07m	6.3ft	1.92m
3.0ft	0.91m	21fc	5.3ft	1.62m	9.5ft	2.90m
4.0ft	1.22m	12fc	7.1ft	2.16m	12.7ft	3.87m

Delivered Lumen: 351.7lm  
 ■ Vertical Beam Spread: 121.1°  
 ■ Horizontal Beam Spread: 115.7°

6W, 1' (305mm), 3000K, 90+ CRI, Prismatic Lens

Polar Candela Distribution

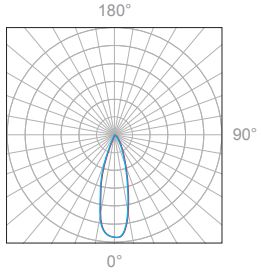

Beam Width: 30°



Illuminance at a Distance

Distance		Center Beam fc	Beam Width			
0.5ft	0.15m	1145fc	0.3ft	0.09m	0.3ft	0.09m
1.0ft	0.30m	591fc	0.5ft	0.15m	0.5ft	0.15m
2.0ft	0.61m	210fc	1.1ft	0.34m	1.1ft	0.34m
3.0ft	0.91m	100fc	1.6ft	0.49m	1.6ft	0.49m
4.0ft	1.22m	58fc	2.1ft	0.64m	2.1ft	0.64m

Delivered Lumen: 417.4lm  
 ■ Vertical Beam Spread : 30.2°  
 ■ Horizontal Beam Spread : 30.1°

Polar Candela Distribution

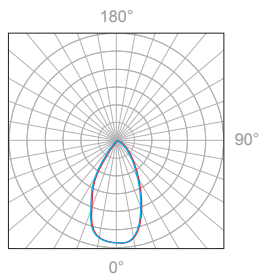

Beam Width: 60°

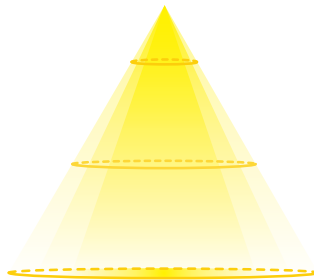

Illuminance at a Distance

Distance		Center Beam fc	Beam Width			
0.5ft	0.15m	1094fc	0.5ft	0.15m	0.5ft	0.15m
1.0ft	0.30m	531fc	1.0ft	0.30m	1.0ft	0.30m
2.0ft	0.61m	166fc	2.1ft	0.64m	2.1ft	0.64m
3.0ft	0.91m	76fc	3.1ft	0.94m	3.1ft	0.94m
4.0ft	1.22m	43fc	4.1ft	1.25m	4.1ft	1.25m

Delivered Lumen: 365.2lm  
 ■ Vertical Beam Spread: 55.4°  
 ■ Horizontal Beam Spread: 56.4°

Polar Candela Distribution

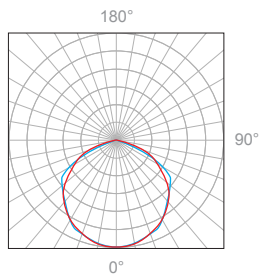

Beam Width: 120°

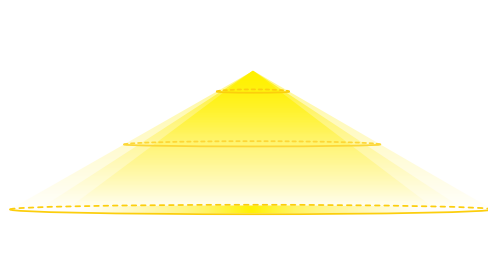

Illuminance at a Distance

Distance		Center Beam fc	Beam Width			
0.5ft	0.15m	708fc	0.9ft	0.27m	1.5ft	0.46m
1.0ft	0.30m	277fc	1.8ft	0.55m	3.0ft	0.91m
2.0ft	0.61m	77fc	3.6ft	1.09m	6.1ft	1.86m
3.0ft	0.91m	34fc	5.4ft	1.65m	9.1ft	2.77m
4.0ft	1.22m	19fc	7.2ft	2.19m	12.1ft	3.69m

Delivered Lumen: 425.7lm  
 ■ Vertical Beam Spread: 119.9°  
 ■ Horizontal Beam Spread: 116.0°

Full Spectrum | W wide 120° only

— Full Spectrum — Standard Illuminant @ 3000K — Ra>80

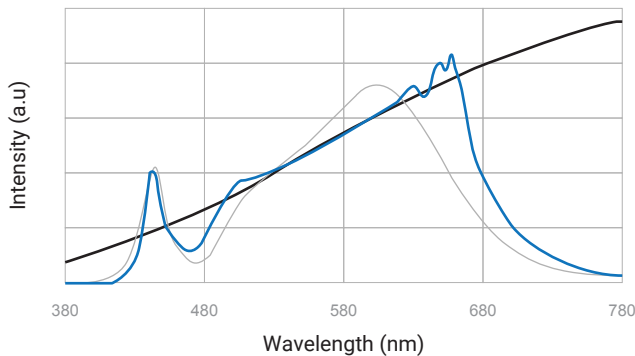

Appendix

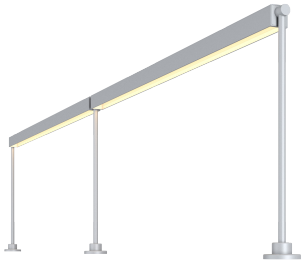

MA matte clear anodized  
shown with MB mounting bracket



MA matte clear anodized  
shown with C22 canopy