

L500

INTERIOR
Recessed Downlight

- Dry location

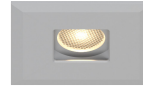

Shown with Coil Spring Clips

Ordering Information

Clear Form

Date : _____

Quantity : _____

Project : _____

Note : _____

Type : _____

Specifications

Luminaire | Example Code: L500-2-W30H-N-BA

Product	Wattage ¹	CCT & CRI ²	Beam Angle	Finish ³
L500	2			
	2 2W	W22S 2200K 80+ W27H 2700K 90+ W30H 3000K 90+ W35H 3500K 90+ W41H 4100K 90+	S spot 12° N narrow flood 30° F flood 45°	Aluminum Finishes: MA matte clear anodized BA black anodized BZ bronze powder coated

System Components (Ordered Separately)

Remote Driver : _____

* Consult MP Lighting Website or Factory.

Important Notes

Specification

1. Available 120V. Consult factory for other voltage options.
2. Refer to pg.2 - for light quality and colour consistency details.
3. Refer to Appendix or MP Lighting website for complete look of luminaire with different finish options.

Warranty Notes & Disclaimer

Malfunction and damage to product due to incompatible dimming system or misuse will not be covered under warranty. Consult MP Lighting for recommended drivers. If the fixture has an option to be installed with a dimming control system, consult a dimming system manufacturer with minimum load before installing. MP Lighting reserves the right, at its sole discretion, at any time and without notice, to make design changes to any of our products. Consult MP Lighting website for most updated documentation.

L500

INTERIOR
Recessed Downlight

- Dry location

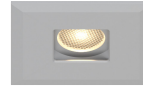

Shown with Coil Spring Clips

Performance

Wattage	Forward Current	Power Consumption Budget per fixture (including driver)	LED output (Source)	Fixture Output (Delivered)
2W	700mA	3W	220 lm	136-147 lm

Application

Environment	Dry Location approved. IP 40.
Mounting	Recessed mount to cabinet millwork with coil spring clips. Comes with 2' (610 mm) wire lead. Cut out size: 2" (610mm)

Electrical

Electrical	Remote LED drivers (120-277V AC input, constant current output). Fixtures to be wired in series.
Control	On/off control Dimming: ELV or 0-10V dimming with appropriate drivers Other options (consult factory): TRIAC/MLV, DMX, DALI, Casambi, Power over Ethernet

Luminaire Construction

LED Light Source	W22S = CCT: 2200K, CRI (Ra): 80+, Colour Consistency: 3SDCM W27H = CCT: 2700K, CRI (Ra): 90+, Colour Consistency: 2SDCM W30H = CCT: 3000K, CRI (Ra): 90+, Colour Consistency: 2SDCM W35H = CCT: 3500K, CRI (Ra): 90+, Colour Consistency: 2SDCM W41H = CCT: 4100K, CRI (Ra): 90+, Colour Consistency: 3SDCM
Weight	0.07lbs (0.03kg)
Material	Fixture: Solid anodized aluminum
Supplied with	Standard installation housing: Comes with universal crossbar and mounting screws (2).
Warranty & LED Life	5 years limited warranty Estimated useful life of LED is 50,000 hours.

Ordered Separately

System Components	Power supplies: remote driver Please consult factory or visit Recommended Drivers for available driver options.
-------------------	---

Mounting Options & Dimensions

LED Fixture Dimensions

Fixture dimension

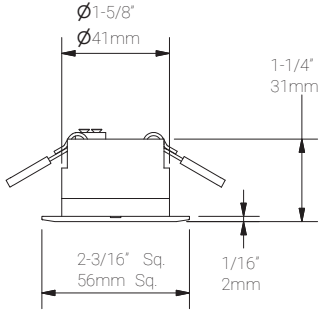

Coil Spring Clip dimension

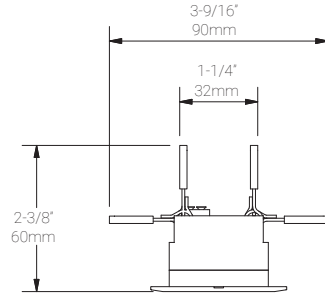

Fixture (Top View)

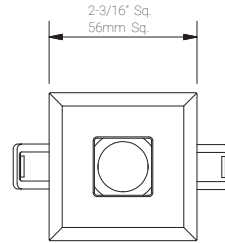

3D View



Appendix

Aluminum Finishes



MA matte clear anodized



BA black anodized



BZ bronze powder coated

2W, 2700K, 90+ CRI

Polar Candela Distribution

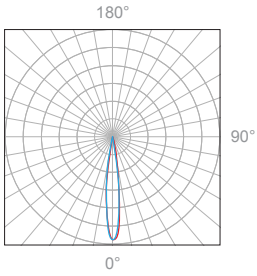

Beam Width: 12°



Illuminance at a Distance

Distance		Center Beam fc	Beam Width			
3.0ft	0.91m	85.0fc	0.2ft	0.06m	0.2ft	0.06m
6.0ft	1.83m	20.0fc	0.5ft	0.15m	0.5ft	0.15m
9.0ft	2.74m	8.9fc	0.7ft	0.21m	0.7ft	0.21m
12ft	3.66m	5.1fc	1.0ft	0.30m	1.0ft	0.30m
15ft	4.57m	3.2fc	1.2ft	0.36m	1.2ft	0.36m
18ft	5.49m	2.2fc	1.5ft	0.45m	1.5ft	0.45m

■ Vertical Beam Spread : 14°
 ■ Horizontal Beam Spread : 14.1°

Polar Candela Distribution

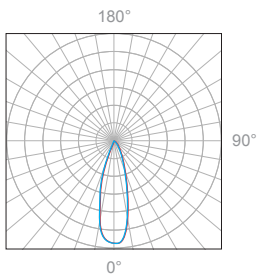

Beam Width: 30°

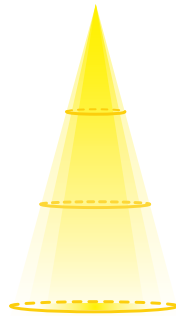

Illuminance at a Distance

Distance		Center Beam fc	Beam Width			
3.0ft	0.91m	77.0fc	0.5ft	0.06m	0.5ft	0.06m
6.0ft	1.83m	19.0fc	1.0ft	0.15m	1.0ft	0.15m
9.0ft	2.74m	8.3fc	1.5ft	0.21m	1.5ft	0.21m
12ft	3.66m	4.7fc	2.0ft	0.30m	2.0ft	0.30m
15ft	4.57m	3.0fc	2.5ft	0.36m	2.5ft	0.36m
18ft	5.49m	2.1fc	3.0ft	0.45m	3.0ft	0.45m

■ Vertical Beam Spread : 28°
 ■ Horizontal Beam Spread : 29.6°

Polar Candela Distribution

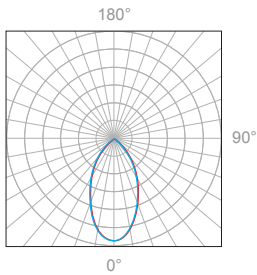

Beam Width: 45°

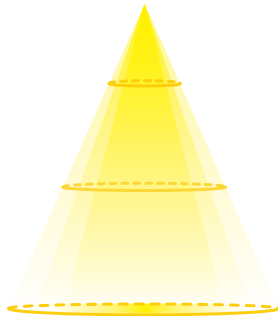

Illuminance at a Distance

Distance		Center Beam fc	Beam Width			
3.0ft	0.91m	22.5fc	2.5ft	0.76m	2.4ft	0.73m
6.0ft	1.83m	5.63fc	4.9ft	1.49m	4.9ft	1.49m
9.0ft	2.74m	2.50fc	7.4ft	2.25m	7.3ft	2.22m
12ft	3.66m	1.41fc	9.8ft	2.98m	9.8ft	2.98m
15ft	4.57m	0.90fc	12.3ft	3.74m	12.2ft	3.71m
18ft	5.49m	0.63fc	14.7ft	4.48m	14.7ft	4.48m

■ Vertical Beam Spread : 44.4°
 ■ Horizontal Beam Spread : 44.3°

Warm Dimming VS. Halogen

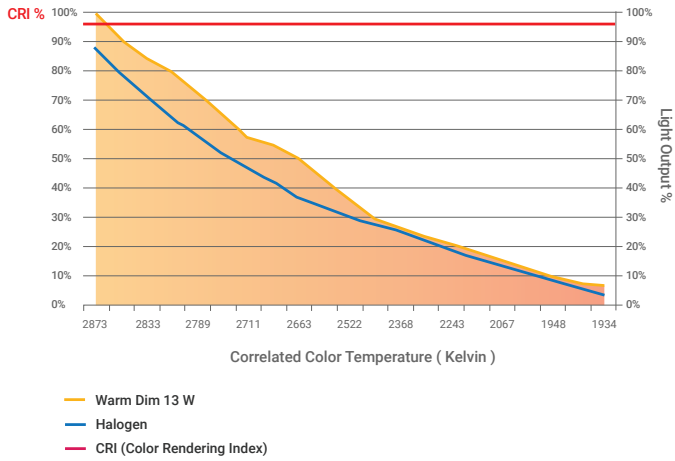

Full Spectrum

Full Spectrum Standard Illuminant @ 3000K Ra≥80

