

L800 series | L801-I225

INTERIOR

Linear | Linear beam series with different insert options

● Dry location

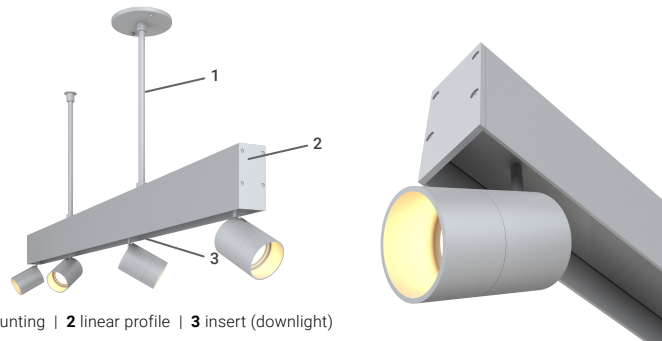

1 mounting | 2 linear profile | 3 insert (downlight)

Ordering Information

Clear Form

Date : _____

Quantity : _____

Project : _____

Note : _____

Type : _____

Specifications

Fixture comprises of 3 components that need to be specified separately: Mounting (only suspended-mount needs specification), Rail, and Insert

Luminaire | Example Code (*Suspended*): U-C12-BA // RAL-801-8-BA // I225M-4-W35H-S-CS-2-BA | (*Surface*): RAL-801-8-BA // I225M-4-W35H-S-CS-2-BA

MOUNTING: Suspended

Surface

COMPONENT 1 – MOUNTING

Mounting	Stem Length or Cable Length	Finish (mounting) ^{1,2}
U		
U suspended	S12 12" (305mm) SX custom ^{1,1} C12 12" (305mm) CX custom ^{1,1}	Aluminum Finishes: MA matte clear anodized BA black anodized

COMPONENT 3 – INSERT

Insert	Wattage	CCT & CRI	Beam Angle	Shrouds	Stem Length	Finishes
I225S						
I225S	1 1W 2 2W	W22S 2200K 80+ W27H 2700K 90+ W30H 3000K 90+ W35H 3500K 90+ W41H 4100K 90+	S spot, 12° N narrow flood, 30°	CS cylinder shroud FS full shroud	2 2" (51mm) X custom ^{3,2}	Aluminum Finishes: MA matte clear anodized BA black anodized

COMPONENT 2 – RAIL

Rail	Fixture Length ^{2,1}	Finish (rail) ^{2,3}
RAL-801		
	1 1' (min.) X custom ^{2,2} 8 8' (max.)	Aluminum Finishes: MA matte clear anodized BA black anodized

Insert	Wattage	CCT & CRI	Beam Angle	Shrouds	Stem Length	Finishes
I225M						
I225M ^{3,1}	4 4W 8 8W	W27H 2700K 90+ W30H 3000K 90+	S spot, 12° N narrow flood, 30° F flood, 48°	CS cylinder shroud	2 2" (51mm) X custom ^{3,2}	Aluminum Finishes: MA matte clear anodized BA black anodized

System Components (Ordered Separately)

Remote Driver : _____

Insert	Wattage	CCT & CRI	Beam Angle	Shrouds	Stem Length	Finishes
I225L						
I225L ^{3,1}	13 13W	W27H 2700K 90+ W30H 3000K 90+ W35H 3500K 90+ W27V 2700K 97+ W30V 3000K 97+	S spot, 12° N narrow flood, 30°	CS cylinder shroud	2 2" (51mm) X custom ^{3,2}	Aluminum Finishes: MA matte clear anodized BA black anodized

Important Notes

Specification

- 1.1 Maximum: 6' (1829mm), 1' (305mm) increments.
- 1.2 Refer to Appendix/MP Lighting website for complete look of luminaire with different finish options.
- 2.1 Fixture length is the length of the fixture without the end caps (3mm each cap).
- 2.2 Maximum: 8' (2438mm), 1' (305mm) increments.

- 2.3 Refer to Appendix/MP Lighting website for complete look of luminaire with different finish options.
- 3.1 Narrow flood and flood options are only available with W27H and W30H options.
- 3.2 Maximum 8' (2438mm) with 6" (152.4mm) increments.

Warranty Notes & Disclaimer

Malfunction and damage to product due to incompatible dimming system or misuse will not be covered under warranty. Consult MP Lighting for recommended drivers. If the fixture has an option to be installed with a dimming control system, consult a dimming system manufacturer with minimum load before installing. MP Lighting reserves the right, at its sole discretion, at any time and without notice, to make design changes to any of our products. Consult MP Lighting website for most updated documentation.

L800 series | L801-I225

INTERIOR

Linear | Linear beam series with different insert options

- Dry location

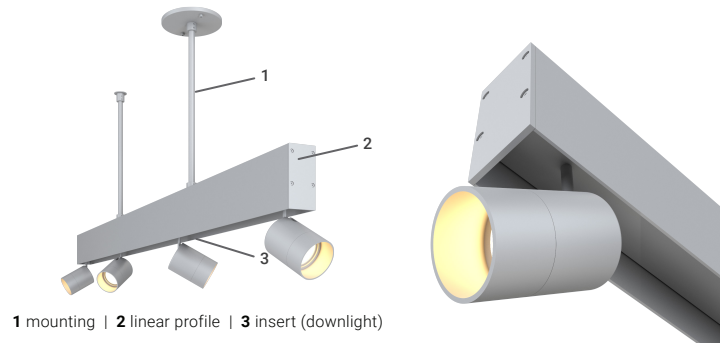

1 mounting | 2 linear profile | 3 insert (downlight)



Performance

Insert	Wattage	Forward Current	Power Consumption Budget per fixture (including driver)	LED output (Source)	Fixture Output (Delivered)
I225S	1W	350mA	1.2W	110 lm	65-75 lm
I225S	2W	700mA	2.9W	220 lm	129-149 lm
I225M	4W	350mA	4.7W	440 lm	208-261 lm
I225M	8W	700mA	8W	880 lm	371-433 lm
I225L	13W	350mA	13W	1430 lm	700-731 lm

Application

Environment	Dry Location approved. IP 50.
Mounting	Surface-mounted: Mounts directly to surface or recessed mount with mounting screws (supplied by others). Suspension-mounted: Suspended from ceiling with a stand off and a canopy (both ordered separately).

Electrical

Power Supplies	Recommended drivers (consult factory): TLDAV100W24V04iB or TLDAV100W24V05iB. Remote LED drivers (120-277V AC input, constant current output): Fixtures to be wired in series.
Control	Dimming: ELV or 0-10V dimming with appropriate drivers. Other options (consult factory): TRIAC/MLV, DMX, DALI, Casambi, Power over Ethernet.

Luminaire Construction

LED Light Source	W22S = CCT: 2200K, CRI (Ra): 80+, Colour Consistency: 3SDCM W27H = CCT: 2700K, CRI (Ra): 90+, Colour Consistency: 2SDCM W30H = CCT: 3000K, CRI (Ra): 90+, Colour Consistency: 2SDCM W35H = CCT: 3500K, CRI (Ra): 90+, Colour Consistency: 2SDCM W41H = CCT: 4100K, CRI (Ra): 90+, Colour Consistency: 3SDCM W27V = CCT: 2700K, CRI (Ra): 97+, Colour Consistency: 2SDCM W30V = CCT: 3000K, CRI (Ra): 97+, Colour Consistency: 2SDCM
Weight	N/A.
Material	Fixture: extruded marine-grade aluminum with polycarbonate lens.
Supplied with	Cable: 3' (914mm) factory-installed wire lead (for surface mount).
Warranty & LED Life	5 years limited warranty. Estimated useful life of LED is 50,000 hours.

Ordered Separately

System Components	Power supplies: remote driver Please consult factory or visit Recommended Drivers for available driver options.
-------------------	---

Mounting Options & Dimensions

LED Fixture Dimensions | Surface-mount

Fixture

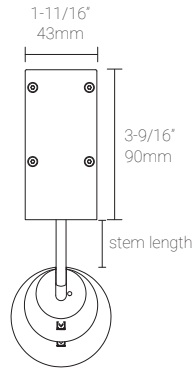

Side View

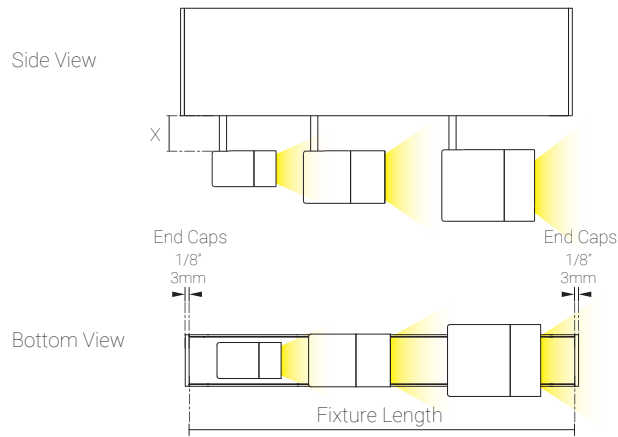

3D View - shown with I225L

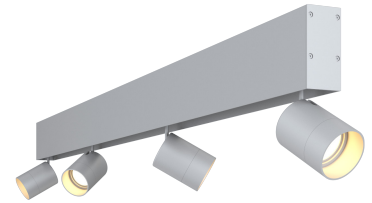

Surface-mount Installation | shown without spotlights

Fixture

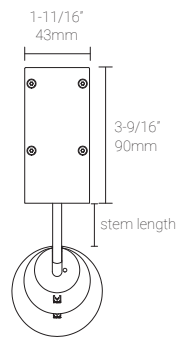

Fixture installed - Side

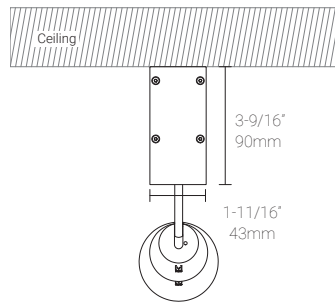

Fixture installed - Front

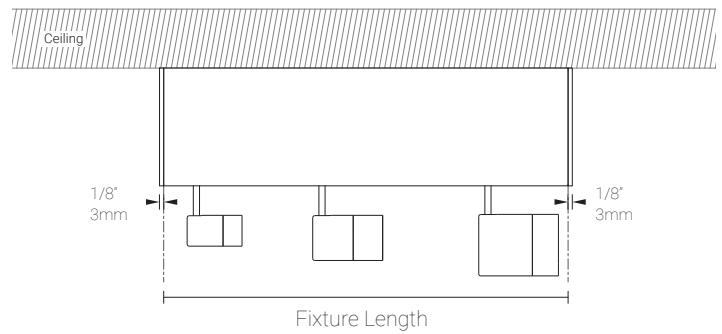

Suspended-mount Installation

Fixture

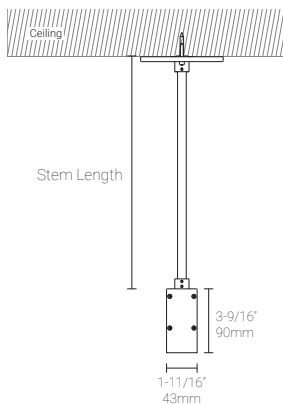

Mounting Dimensions

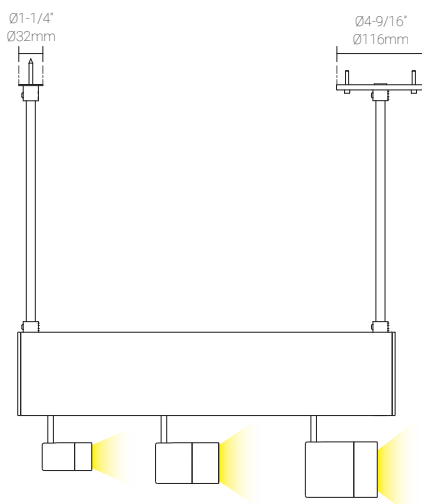

Fixture installed

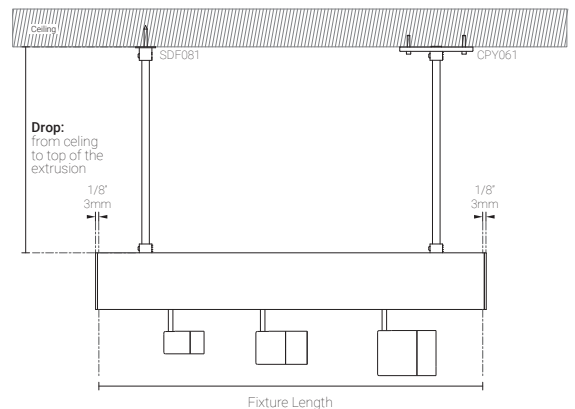

I225S 1W, 4' (1219mm), 2700K, 90+ CRI

Polar Candela Distribution

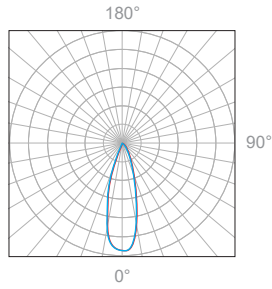

Beam Width: 12°



Illuminance at a Distance

Distance		Center Beam fc	Beam Width			
3.0ft	0.91m	50.3fc	1.0ft	0.30m	1.0ft	0.30m
6.0ft	1.83m	12.6fc	2.1ft	0.64m	2.1ft	0.64m
9.0ft	2.74m	5.5fc	3.1ft	0.94m	3.1ft	0.94m
12.0ft	3.66m	3.1fc	4.1ft	1.25m	4.1ft	1.25m
15.0ft	4.57m	2.0fc	5.2ft	1.58m	5.2ft	1.58m
18.0ft	5.49m	1.4fc	6.2ft	1.89m	6.2ft	1.89m

Delivered Lumen: 65lm
 ■ Vertical Beam Spread: 19.5°
 ■ Horizontal Beam Spread: 19.5°

Polar Candela Distribution

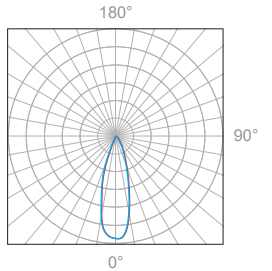

Beam Width: 30°

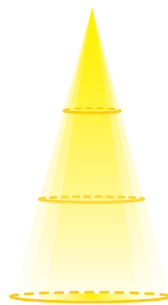

Illuminance at a Distance

Distance		Center Beam fc	Beam Width			
3.0ft	0.91m	35fc	1.4ft	0.43m	1.4ft	0.43m
6.0ft	1.83m	8.7fc	2.9ft	0.88m	2.9ft	0.88m
9.0ft	2.74m	3.9fc	4.3ft	1.31m	4.3ft	1.31m
12.0ft	3.66m	2.1fc	5.7ft	1.74m	5.7ft	1.74m
15.0ft	4.57m	1.4fc	7.2ft	2.19m	7.2ft	2.19m
18.0ft	5.49m	0.9fc	8.6ft	2.62m	8.6ft	2.62m

Delivered Lumen: 75lm
 ■ Vertical Beam Spread: 28.5°
 ■ Horizontal Beam Spread: 28.7°

I225S 2W, 4' (1219mm), 2700K, 90+ CRI

Polar Candela Distribution

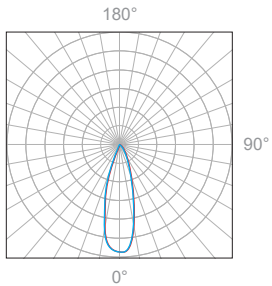

Beam Width: 12°



Illuminance at a Distance

Distance		Center Beam fc	Beam Width			
3.0ft	0.91m	103fc	1.0ft	0.30m	1.0ft	0.30m
6.0ft	1.83m	25.9fc	2.0ft	0.60m	2.0ft	0.60m
9.0ft	2.74m	11.5fc	3.0ft	0.91m	3.0ft	0.91m
12.0ft	3.66m	6.47fc	4.0ft	1.22m	4.0ft	1.22m
15.0ft	4.57m	4.14fc	5.0ft	1.52m	5.0ft	1.52m
18.0ft	5.49m	1.87fc	6.0ft	1.83m	6.0ft	1.83m

Delivered Lumen: 129lm
 ■ Vertical Beam Spread: 19°
 ■ Horizontal Beam Spread: 19°

Polar Candela Distribution

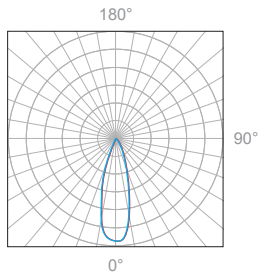

Beam Width: 30°

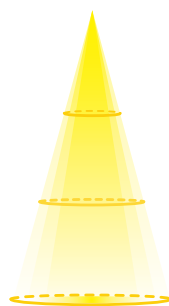

Illuminance at a Distance

Distance		Center Beam fc	Beam Width			
3.0ft	0.91m	69.5fc	1.5ft	0.46m	1.5ft	0.46m
6.0ft	1.83m	17.4fc	3.0ft	0.91m	3.0ft	0.91m
9.0ft	2.74m	7.73fc	4.5ft	1.37m	4.5ft	1.37m
12.0ft	3.66m	4.35fc	6.0ft	1.83m	6.0ft	1.83m
15.0ft	4.57m	2.78fc	7.6ft	2.32m	7.6ft	2.32m
18.0ft	5.49m	1.93fc	9.1ft	2.77m	9.1ft	2.77m

Delivered Lumen: 149lm
 ■ Vertical Beam Spread: 28.3°
 ■ Horizontal Beam Spread: 28.3°

I225M 4W, 4' (1219mm), 2700K, 90+ CRI

Polar Candela Distribution

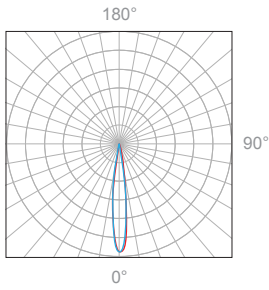

Beam Width: 12°



Illuminance at a Distance

Distance		Center Beam fc	Beam Width			
3.0ft	0.91m	180.3fc	1.0ft	0.30m	1.0ft	0.30m
6.0ft	1.83m	30.9fc	2.1ft	0.64m	2.1ft	0.64m
9.0ft	2.74m	19.2fc	3.1ft	0.94m	3.1ft	0.94m
12.0ft	3.66m	10.7fc	4.1ft	1.25m	4.1ft	1.25m
15.0ft	4.57m	7.3fc	5.2ft	1.58m	5.2ft	1.58m
18.0ft	5.49m	5fc	6.2ft	1.89m	6.2ft	1.89m

Delivered Lumen: 261 lm
 ■ Vertical Beam Spread: 19.5°
 ■ Horizontal Beam Spread: 19.5°

Polar Candela Distribution

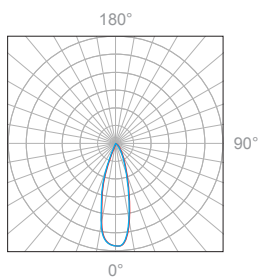

Beam Width: 30°



Illuminance at a Distance

Distance		Center Beam fc	Beam Width			
3.0ft	0.91m	114.2fc	1.4ft	0.43m	1.4ft	0.43m
6.0ft	1.83m	28.8fc	2.9ft	0.88m	2.9ft	0.88m
9.0ft	2.74m	12.8fc	4.3ft	1.31m	4.3ft	1.31m
12.0ft	3.66m	7.5fc	5.7ft	1.74m	5.7ft	1.74m
15.0ft	4.57m	4.8fc	7.2ft	2.19m	7.2ft	2.19m
18.0ft	5.49m	3.4fc	8.6ft	2.62m	8.6ft	2.62m

Delivered Lumen: 251 lm
 ■ Vertical Beam Spread: 26.9°
 ■ Horizontal Beam Spread: 26.9°

Polar Candela Distribution

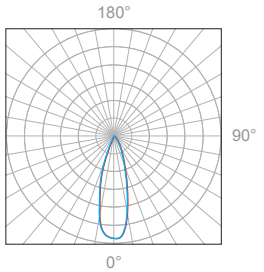

Beam Width: 48°

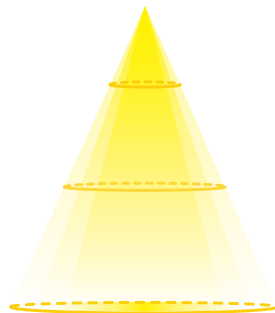

Illuminance at a Distance

Distance		Center Beam fc	Beam Width			
3.0ft	0.91m	45.9fc	2.6ft	0.79m	2.6ft	0.79m
6.0ft	1.83m	11.7fc	5.3ft	1.62m	5.3ft	1.62m
9.0ft	2.74m	5.2fc	7.9ft	2.41m	7.9ft	2.41m
12.0ft	3.66m	3fc	10.6ft	3.23m	10.6ft	3.23m
15.0ft	4.57m	2fc	13.2ft	4.02m	13.2ft	4.02m
18.0ft	5.49m	1.6fc	15.9ft	4.85m	15.9ft	4.85m

Delivered Lumen: 224 lm
 ■ Vertical Beam Spread: 47.6°
 ■ Horizontal Beam Spread: 47.6°

I225M 8W, 4' (1219mm), 2700K, 90+ CRI

Polar Candela Distribution

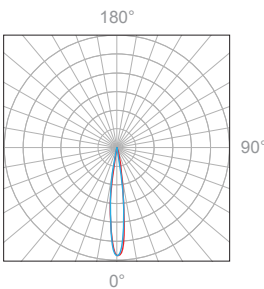

Beam Width: 12°



Illuminance at a Distance

Distance		Center Beam fc	Beam Width			
3.0ft	0.91m	328.6fc	1.0ft	0.30m	1.0ft	0.30m
6.0ft	1.83m	79fc	2.1ft	0.64m	2.1ft	0.64m
9.0ft	2.74m	35.2fc	3.1ft	0.94m	3.1ft	0.94m
12.0ft	3.66m	19.2fc	4.1ft	1.25m	4.1ft	1.25m
15.0ft	4.57m	12.8fc	5.2ft	1.58m	5.2ft	1.58m
18.0ft	5.49m	9.1fc	6.2ft	1.89m	6.2ft	1.89m

Delivered Lumen: 433 lm
 ■ Vertical Beam Spread: 19.5°
 ■ Horizontal Beam Spread: 19.5°

I225M 8W, 4' (1219mm), 2700K, 90+ CRI

Polar Candela Distribution

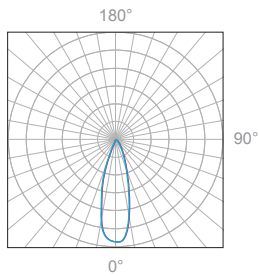

Beam Width: 30°

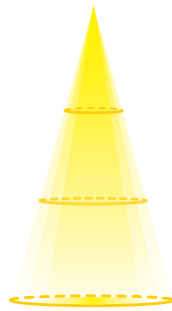

Illuminance at a Distance

Distance		Center Beam fc	Beam Width			
3.0ft	0.91m	202.7fc	1.4ft	0.43m	1.4ft	0.43m
6.0ft	1.83m	50.1fc	2.9ft	0.88m	2.9ft	0.88m
9.0ft	2.74m	21.3fc	4.3ft	1.31m	4.3ft	1.31m
12.0ft	3.66m	11.7fc	5.7ft	1.74m	5.7ft	1.74m
15.0ft	4.57m	8.2fc	7.2ft	2.19m	7.2ft	2.19m
18.0ft	5.49m	6.3fc	8.6ft	2.62m	8.6ft	2.62m

Delivered Lumen: 418 lm
 ■ Vertical Beam Spread: 26.9°
 ■ Horizontal Beam Spread: 26.9°

Polar Candela Distribution

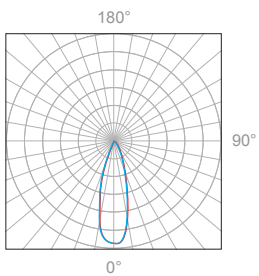

Beam Width: 48°

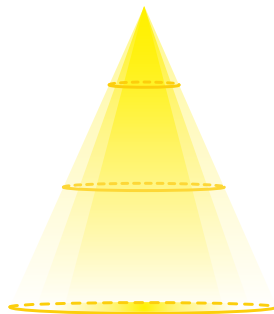

Illuminance at a Distance

Distance		Center Beam fc	Beam Width			
3.0ft	0.91m	75.7fc	2.6ft	0.79m	2.6ft	0.79m
6.0ft	1.83m	19.2fc	5.3ft	1.62m	5.3ft	1.62m
9.0ft	2.74m	8.5fc	7.9ft	2.41m	7.9ft	2.41m
12.0ft	3.66m	4.9fc	10.6ft	3.23m	10.6ft	3.23m
15.0ft	4.57m	3.3fc	13.2ft	4.02m	13.2ft	4.02m
18.0ft	5.49m	2.3fc	15.9ft	4.85m	15.9ft	4.85m

Delivered Lumen: 372 lm
 ■ Vertical Beam Spread: 47.6°
 ■ Horizontal Beam Spread: 47.6°

I225L 13W, 4' (1219mm), 2700K, 90+ CRI

Polar Candela Distribution

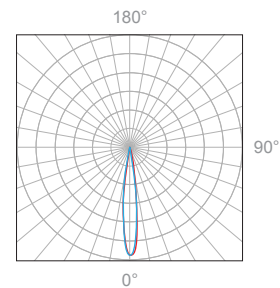

Beam Width: 12°



Illuminance at a Distance

Distance		Center Beam fc	Beam Width			
3.0ft	0.91m	331.0fc	1.0ft	0.30m	1.0ft	0.30m
6.0ft	1.83m	82.9fc	2.0ft	0.61m	2.0ft	0.61m
9.0ft	2.74m	36.8fc	3.1ft	0.94m	3.1ft	0.94m
12.0ft	3.66m	20.7fc	4.1ft	1.25m	4.1ft	1.25m
15.0ft	4.57m	13.3fc	5.1ft	1.55m	5.1ft	1.55m
18.0ft	5.49m	9.21fc	6.1ft	1.86m	6.1ft	1.86m

Delivered Lumen: 699 lm
 ■ Vertical Beam Spread: 19.4°
 ■ Horizontal Beam Spread: 19.4°

Polar Candela Distribution

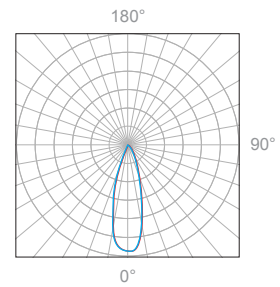

Beam Width: 30°

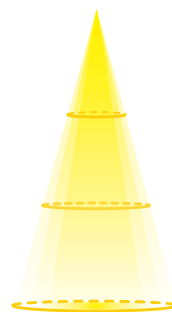

Illuminance at a Distance

Distance		Center Beam fc	Beam Width			
3.0ft	0.91m	206fc	1.6ft	0.48m	1.6ft	0.48m
6.0ft	1.83m	51.4fc	3.1ft	0.94m	3.1ft	0.94m
9.0ft	2.74m	22.8fc	4.7ft	1.43m	4.7ft	1.43m
12.0ft	3.66m	12.8fc	6.3ft	1.92m	6.3ft	1.92m
15.0ft	4.57m	8.22fc	7.9ft	2.40m	7.9ft	2.40m
18.0ft	5.49m	5.71fc	9.4ft	2.86m	9.4ft	2.86m

Delivered Lumen: 731.3 lm
 ■ Vertical Beam Spread: 29.4°
 ■ Horizontal Beam Spread: 29.4°

Appendix

Aluminum Finishes, Mounts, and Accessories | I225S



MA matte clear anodized surface mounted



BA black anodized surface mounted



MA matte clear anodized suspension mounted



BA black anodized suspension mounted



MA matte clear anodized CS canopy shroud



BA black anodized CS canopy shroud



MA matte clear anodized FS full shroud



BA black anodized FS full shroud

Aluminum Finishes, Mounts, and Accessories | I225M

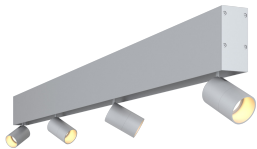

MA matte clear anodized surface mounted



BA black anodized surface mounted



MA matte clear anodized suspension mounted



BA black anodized suspension mounted



MA matte clear anodized CS canopy shroud



BA black anodized CS canopy shroud

Aluminum Finishes, Mounts, and Accessories | I225L



MA matte clear anodized surface mounted



BA black anodized surface mounted



MA matte clear anodized suspension mounted



BA black anodized suspension mounted



MA matte clear anodized CS canopy shroud



BA black anodized CS canopy shroud