

X51 SR

Installation Instructions

SR Fixture Connector

- 1** Unscrew connector cap and open connector.
- 2** Place fixture on rail in desired location.
- 3** Close connector and tighten cap.
- 4** Push in jack connector and thread cap until secure.

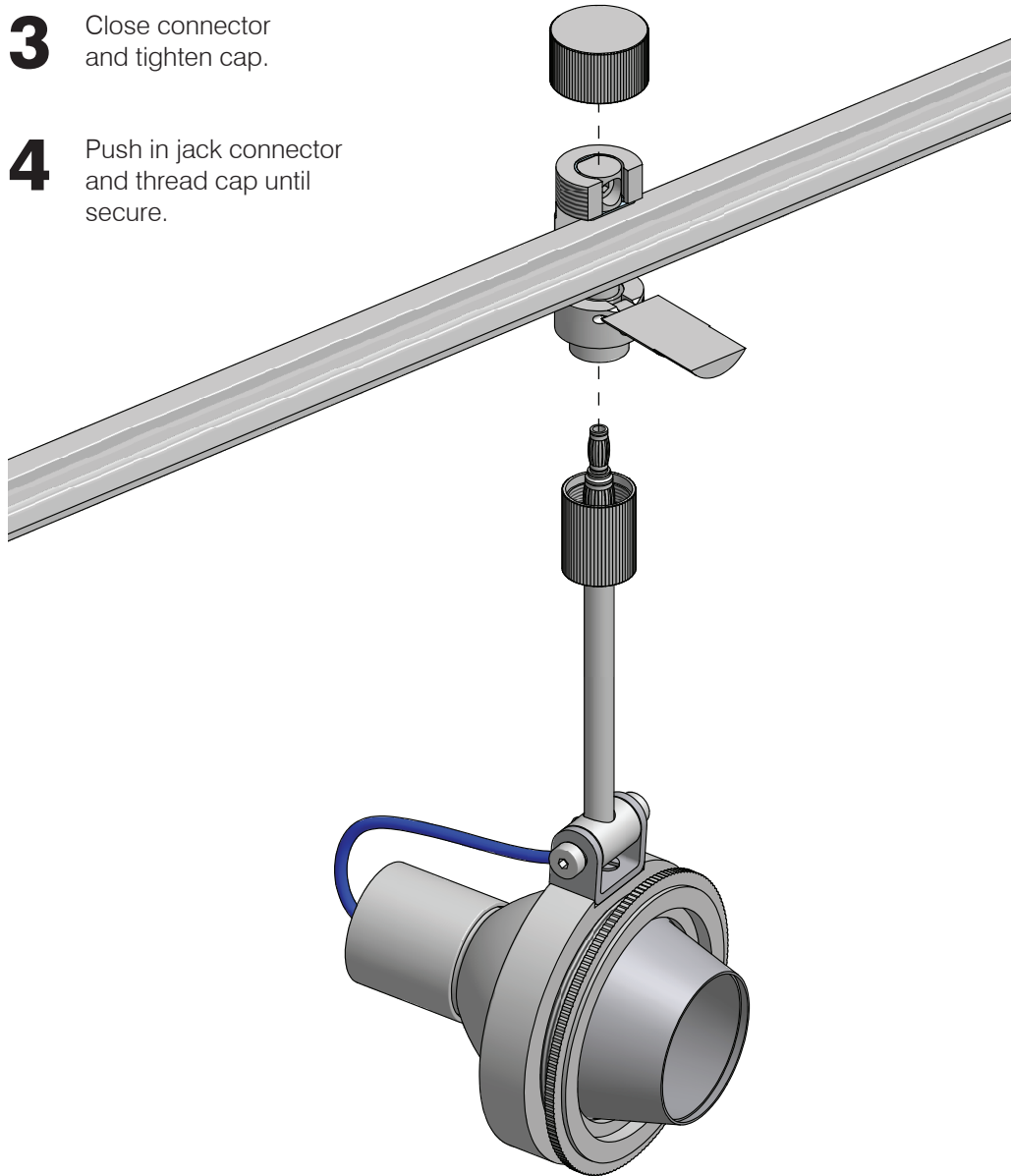

CAUTION

- Read all instructions.
- Do not move fixture along rail while power is on.
- Ensure cap is tight to prevent short circuit from occurring.
- Leave system on to test installation for 20-30 minutes. Heat indicates a loose connection. Check if any connections on the system are warmer than your body temperature. If a connection is very warm, turn off system and retighten that connection.
- Keep this document as a reference.