



# L114T

- Application** Interior/Exterior linear cove, wall slot, shelf and cabinet illumination.
- IP Rating** 52
- Mounting** Mounts with stem and mounting bracket
- Electrical** 2W/ft  
6W/ft  
10W/ft  
Powered by 24V DC driver.  
*\*See website for recommended drivers*
- Power Consumption** 2W/ft(304.8mm) = 2.2W (at 81mA, 2 watt)  
6W/ft(304.8mm) = 7W (at 250mA, 6 watt)  
10W/ft(304.8mm) = 11.5W (at 420mA, 10 watt)
- Light Output** 2W/ft(304.8mm), 95lm~119lm  
6W/ft(304.8mm), 322lm~352lm  
10W/ft(304.8mm), 496~637lm  
*\*For photometric data, see page 02*
- Warranty** 5 years limited warranty  
Estimated useful life of LED is 50,000 hours.
- Material** Anodized aluminum and polycarbonate. RoHS compliant.

**Approval** 

- Type:**
- Project:**
- Modified:**
- Quantity:**
- Notes:**

**DISCLAIMER** - When using a control system, consult dimming system manufacturer with minimum load before installing. Malfunction and damage to product due to improper dimming system installation or misuse will not be covered under warranty. Only DC Drivers are recommended for dimming systems. Consult MP Lighting for recommended drivers.

\*MP Lighting reserves the right, at its sole discretion, at any time and without notice, to make design changes to any of our products.

## Order Guide

Example: L114T-MB-B-X-X-W30H-W-F-X-MA

| Code           | Mounting                     | Wattage                              | Length 1  | Length 2  | Color  | Beam  | Lens  | Stem   | Finish                           |
|----------------|------------------------------|--------------------------------------|---|---|--|---|---|--|----------------------------------|
| <b>L114T -</b> | <b>MB</b>                    |                                      |   |   |  |   |   |  |                                  |
|                | <b>MB</b> = mounting bracket | <b>A</b> = 2W/ft<br><b>B</b> = 6W/ft | <b>X</b> = custom<br><i>*minimum 1ft long (305mm)</i><br>6" (152mm)<br>increments up to 4' (1219mm) max | <b>X</b> = custom<br><i>*minimum 1ft long (305mm)</i><br>6" (152mm)<br>increments up to 4' (1219mm) max | <b>W27H</b> = 2700K, 90+CRI<br><b>W30H</b> = 3000K, 90+CRI | <b>N</b> = narrow (30°)<br><b>F</b> = flood (60°)<br><b>W</b> = wide (120°) | <b>F</b> = flat frosted<br><b>P</b> = prismatic | <b>6</b> =6" (152mm)<br><b>12</b> =12" (305mm)<br><b>X</b> = custom up to 48" (1219mm) | <b>MA</b> = matte clear anodized |

Example: L114T-MB-B-X-X-W30H-W-F-X-MA

| Code           | Mounting                     | Wattage           | Length 1  | Length 2  | Color   | Beam                   | Lens  | Stem   | Finish                           |
|----------------|------------------------------|-------------------|---|---|---|------------------------|---|--|----------------------------------|
| <b>L114T -</b> | <b>MB</b>                    | <b>C</b>          |   |   |   | <b>W</b>               |   |  |                                  |
|                | <b>MB</b> = mounting bracket | <b>C</b> = 10W/ft | <b>X</b> = custom<br><i>*minimum 1ft long (305mm)</i><br>6" (152mm)<br>increments up to 4' (1219mm) max | <b>X</b> = custom<br><i>*minimum 1ft long (305mm)</i><br>6" (152mm)<br>increments up to 4' (1219mm) max | <b>W22S</b> = 2200K, 80+CRI<br><b>W27H</b> = 2700K, 90+CRI<br><b>W30H</b> = 3000K, 90+CRI<br><b>W35H</b> = 3500K, 90+CRI<br><b>W41H</b> = 4100K, 90+CRI | <b>W</b> = wide (120°) | <b>F</b> = flat frosted<br><b>P</b> = prismatic | <b>6</b> =6" (152mm)<br><b>12</b> =12" (305mm)<br><b>X</b> = custom up to 48" (1219mm) | <b>MA</b> = matte clear anodized |

**DIMENSION:**

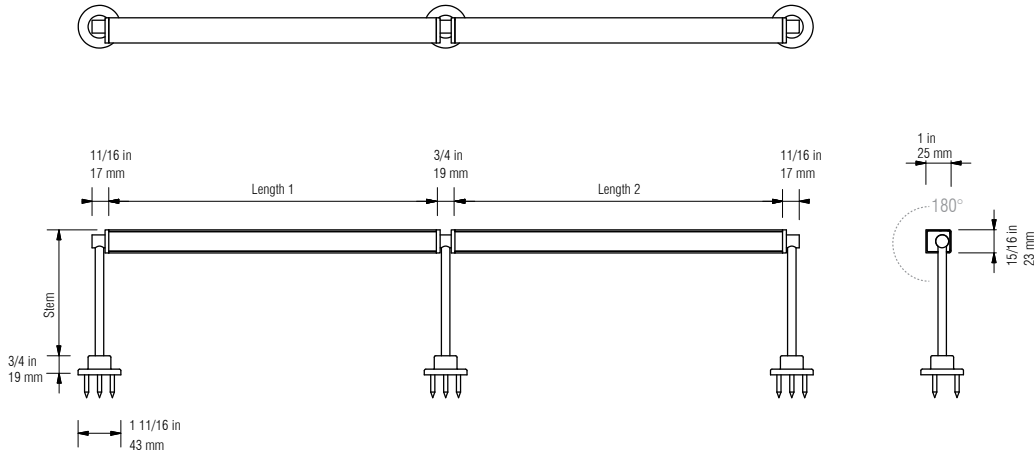

**PHOTOMETRIC DATA:**

**L114**  
2W/FT  
30°  
3000K Std  
111.7 lm  
Frosted Lens

**Polar Candela Distribution**

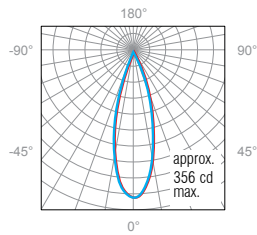

**Illuminance at a Distance**

|      | Center Beam FC | Beam Width  |             |
|------|----------------|-------------|-------------|
| 1.5' | 158            | 0.8'(0.24m) | 0.8'(0.24m) |
| 3.0' | 39.6           | 1.6'(0.48m) | 1.6'(0.48m) |
| 4.5' | 17.6           | 2.4'(0.73m) | 2.4'(0.73m) |
| 6.0' | 9.9            | 3.3'(1.01m) | 3.3'(1.01m) |
| 7.5' | 6.34           | 4.1'(1.25m) | 4.1'(1.25m) |
| 9.0' | 4.40           | 4.9'(1.49m) | 4.9'(1.49m) |

0° Spread: 30.4° 90° Spread: 30.3°

**L114**  
2W/FT  
60°  
3000K Std  
95.3 lm  
Frosted Lens

**Polar Candela Distribution**

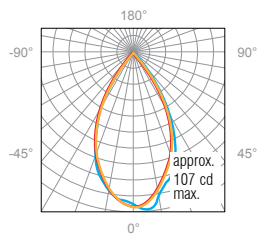

**Illuminance at a Distance**

|      | Center Beam FC | Beam Width |            |
|------|----------------|------------|------------|
| 1.5' | 45.7           | 1.6'(0.5m) | 1.6'(0.5m) |
| 3.0' | 11.4           | 3.2'(1.0m) | 3.2'(1.0m) |
| 4.5' | 5.08           | 4.8'(1.5m) | 4.8'(1.5m) |
| 6.0' | 2.85           | 6.4'(2.0m) | 6.4'(2.0m) |
| 7.5' | 1.83           | 7.9'(2.4m) | 8.0'(2.4m) |
| 9.0' | 1.27           | 9.5'(2.9m) | 9.6'(2.9m) |

0° Spread: 55.9° 90° Spread: 56.1°

**L114**  
2W/FT  
120°  
3000K Std  
118.6lm  
Frosted Lens

**Polar Candela Distribution**

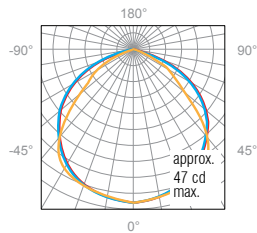

**Illuminance at a Distance**

|      | Center Beam FC | Beam Width   |              |
|------|----------------|--------------|--------------|
| 1.5' | 20.9           | 2.7'(0.82m)  | 4.7'(1.43m)  |
| 3.0' | 5.22           | 5.3'(1.62m)  | 9.5'(2.90m)  |
| 4.5' | 2.23           | 8.0'(2.44m)  | 14.2'(4.33m) |
| 6.0' | 1.30           | 10.7'(3.26m) | 19.0'(5.79m) |
| 7.5' | 0.84           | 13.3'(4.05m) | 23.7'(7.22m) |
| 9.0' | 0.58           | 16.0'(4.88m) | 28.4'(8.66m) |

0° Spread: 83.3° 90° Spread: 115.3°

**PHOTOMETRIC DATA:**

**L114**  
6W/FT  
30°  
3000K Std  
344.2 lm  
Frosted Lens

**Polar Candela Distribution**

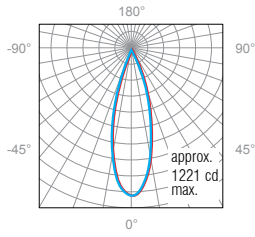

**Illuminance at a Distance**

|      | Center Beam FC | Beam Width  |             |
|------|----------------|-------------|-------------|
| 1.5' | 498            | 0.8'(0.24m) | 0.8'(0.24m) |
| 3.0' | 125            | 1.6'(0.48m) | 1.6'(0.48m) |
| 4.5' | 55.3           | 2.4'(0.73m) | 2.4'(0.73m) |
| 6.0' | 31.1           | 3.3'(1.01m) | 3.3'(1.01m) |
| 7.5' | 19.9           | 4.1'(1.25m) | 4.1'(1.25m) |
| 9.0' | 13.8           | 4.9'(1.49m) | 4.9'(1.49m) |

0° Spread: 30.3°    90° Spread: 30.2°

**L114**  
6W/FT  
60°  
3000K Std  
322.7 lm  
Frosted Lens

**Polar Candela Distribution**

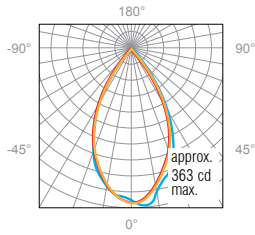

**Illuminance at a Distance**

|      | Center Beam FC | Beam Width |            |
|------|----------------|------------|------------|
| 1.5' | 156            | 1.6'(0.5m) | 1.6'(0.5m) |
| 3.0' | 39             | 3.2'(1.0m) | 3.2'(1.0m) |
| 4.5' | 17.3           | 4.8'(1.5m) | 4.8'(1.5m) |
| 6.0' | 9.74           | 6.4'(2.0m) | 6.4'(2.0m) |
| 7.5' | 6.23           | 7.9'(2.4m) | 8.0'(2.4m) |
| 9.0' | 4.99           | 9.5'(2.9m) | 9.6'(2.9m) |

0° Spread: 55.8°    90° Spread: 56.2°

**L114**  
6W/FT  
120°  
3000K Std  
351.7lm  
Frosted Lens

**Polar Candela Distribution**

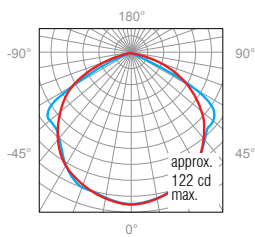

**Illuminance at a Distance**

|      | Center Beam FC | Beam Width   |              |
|------|----------------|--------------|--------------|
| 1.5' | 54.2           | 5.3'(1.62m)  | 4.8'(1.46m)  |
| 3.0' | 13.5           | 10.6'(3.23m) | 9.5'(2.90m)  |
| 4.5' | 6.02           | 15.9'(4.85m) | 14.3'(4.36m) |
| 6.0' | 3.39           | 21.3'(6.49m) | 19.1'(5.82m) |
| 7.5' | 2.17           | 26.6'(8.11m) | 23.9'(7.28m) |
| 9.0' | 1.50           | 31.9'(9.69m) | 28.6'(8.72m) |

0° Spread: 121.1°    90° Spread: 115.7°

**L114**  
10W/FT  
120°  
3000K Std  
602.5lm  
Clear Lens

**Polar Candela Distribution**

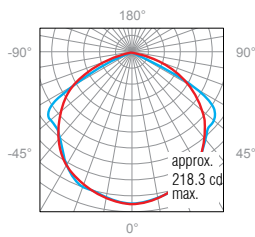

**Illuminance at a Distance**

|      | Center Beam FC | Beam Width   |              |
|------|----------------|--------------|--------------|
| 1.5' | 96.8           | 5.0'(1.52m)  | 4.6'(1.46m)  |
| 3.0' | 24.2           | 9.9'(3.02m)  | 9.1'(2.77m)  |
| 4.5' | 10.8           | 14.9'(4.54m) | 13.7'(4.18m) |
| 6.0' | 6.05           | 19.9'(6.07m) | 18.3'(5.58m) |
| 7.5' | 3.87           | 24.9'(7.59m) | 22.9'(6.98m) |
| 9.0' | 2.69           | 29.8'(9.08m) | 27.0'(8.23m) |

0° Spread: 117.8°    90° Spread: 113.5°

**L114**  
10W/FT  
120°  
3000K Std  
496.1lm  
Frosted Lens

**Polar Candela Distribution**

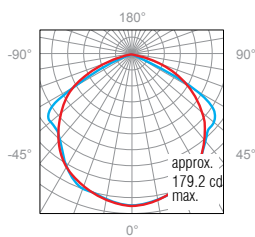

**Illuminance at a Distance**

|      | Center Beam FC | Beam Width   |              |
|------|----------------|--------------|--------------|
| 1.5' | 79.5           | 5.1'(1.55m)  | 4.5'(1.37m)  |
| 3.0' | 19.9           | 10.2'(3.11m) | 9.1'(2.77m)  |
| 4.5' | 8.83           | 15.3'(4.66m) | 13.6'(4.15m) |
| 6.0' | 4.97           | 20.4'(6.22m) | 18.2'(5.55m) |
| 7.5' | 3.18           | 25.5'(7.77m) | 22.7'(6.92m) |
| 9.0' | 2.21           | 30.6'(9.33m) | 27.3'(8.32m) |

0° Spread: 119.1°    90° Spread: 113.2°