



L114

- Application** Interior/Exterior linear cove, wall slot, shelf and cabinet illumination.
- IP Rating** 52
- Mounting** Mounts with stem and mounting bracket
- Electrical** 2W/ft
6W/ft
10W/ft
Powered by 24V DC driver.
**See website for recommended drivers*
- Power Consumption** 2W/ft(304.8mm) = 2.2W (at 81mA, 2 watt)
6W/ft(304.8mm) = 7W (at 250mA, 6 watt)
10W/ft(304.8mm) = 11.5W (at 420mA, 10 watt)
- Light Output** 2W/ft(304.8mm), 95lm~119lm
6W/ft(304.8mm), 322lm~352lm
10W/ft(304.8mm), 496~637lm
**For photometric data, see page 02*
- Warranty** 5 years limited warranty
Estimated useful life of LED is 50,000 hours.
- Material** Anodized aluminum and polycarbonate. RoHS compliant.

Approval 

- Type:**
- Project:**
- Modified:**
- Quantity:**
- Notes:**

DISCLAIMER - When using a control system, consult dimming system manufacturer with minimum load before installing. Malfunction and damage to product due to improper dimming system installation or misuse will not be covered under warranty. Only DC Drivers are recommended for dimming systems. Consult MP Lighting for recommended drivers.

*MP Lighting reserves the right, at its sole discretion, at any time and without notice, to make design changes to any of our products.

Order Guide

Example: L114-MB-A-X-W30H-N-F-X-MA

Code	Mounting	Wattage	Length	Color	Beam	Lens	Stem	Finish
L114	- MB							-
	MB = mounting bracket	A = 2W/ft B = 6W/ft	X = custom <i>*minimum 1ft long (305mm) 6" (152mm) increments up to 4' (1219mm) max</i>	W27H = 2700K, 90+CRI W30H = 3000K, 90+CRI	N = narrow (30°) F = flood (60°) W = wide (120°)	F = flat frosted P = prismatic	6=6" (152mm) 12=12" (305mm) X = custom up to 48" (1219mm)	MA = matte clear anodized

Example: L114-MB-B-X-W30H-W-F-X-MA

Code	Mounting	Wattage	Length	Color	Beam	Lens	Stem	Finish
L114	- MB	C			W			-
	MB = mounting bracket	C = 10W/ft	X = custom <i>*minimum 1ft long (305mm) 6" (152mm) increments up to 4' (1219mm) max</i>	W22S = 2200K, 80+CRI W27H = 2700K, 90+CRI W30H = 3000K, 90+CRI W35H = 3500K, 90+CRI W41H = 4100K, 90+CRI	W = wide (120°)	F = flat frosted P = prismatic	6=6" (152mm) 12=12" (305mm) X = custom up to 48" (1219mm)	MA = matte clear anodized

DIMENSION:

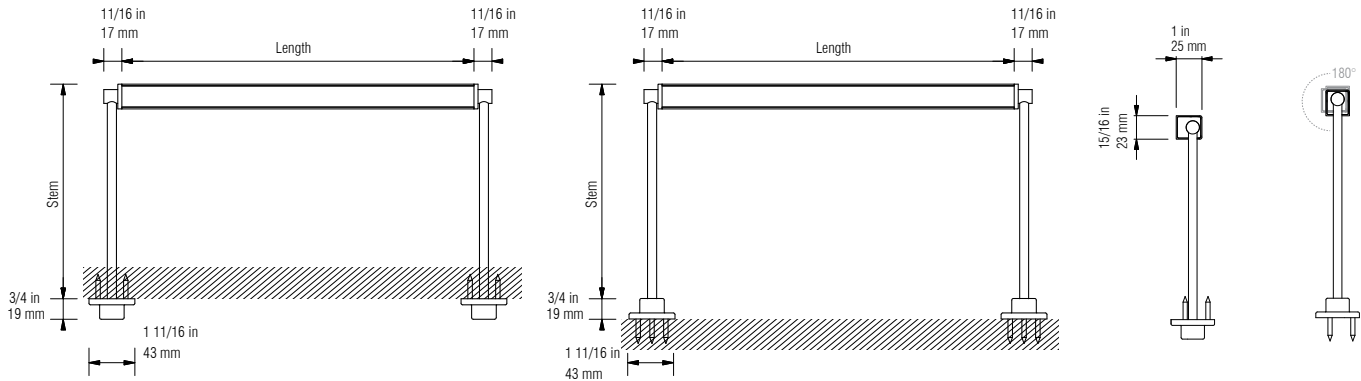

PHOTOMETRIC DATA:

L114
2W/FT
30°
3000K Std
111.7 lm
Frosted Lens

Polar Candela Distribution

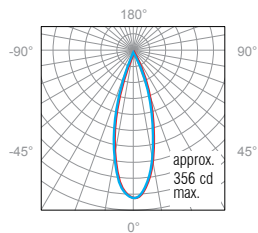

Illuminance at a Distance

	Center Beam FC	Beam Width	
1.5'	158	0.8'(0.24m)	0.8'(0.24m)
3.0'	39.6	1.6'(0.48m)	1.6'(0.48m)
4.5'	17.6	2.4'(0.73m)	2.4'(0.73m)
6.0'	9.9	3.3'(1.01m)	3.3'(1.01m)
7.5'	6.34	4.1'(1.25m)	4.1'(1.25m)
9.0'	4.40	4.9'(1.49m)	4.9'(1.49m)

0° Spread: 30.4° 90° Spread: 30.3°

L114
2W/FT
60°
3000K Std
95.3 lm
Frosted Lens

Polar Candela Distribution

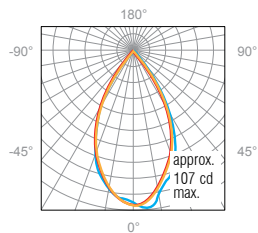

Illuminance at a Distance

	Center Beam FC	Beam Width	
1.5'	45.7	1.6'(0.5m)	1.6'(0.5m)
3.0'	11.4	3.2'(1.0m)	3.2'(1.0m)
4.5'	5.08	4.8'(1.5m)	4.8'(1.5m)
6.0'	2.85	6.4'(2.0m)	6.4'(2.0m)
7.5'	1.83	7.9'(2.4m)	8.0'(2.4m)
9.0'	1.27	9.5'(2.9m)	9.6'(2.9m)

0° Spread: 55.9° 90° Spread: 56.1°

L114
2W/FT
120°
3000K Std
118.6lm
Frosted Lens

Polar Candela Distribution

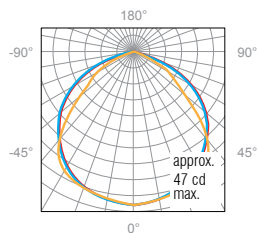

Illuminance at a Distance

	Center Beam FC	Beam Width	
1.5'	20.9	2.7'(0.82m)	4.7'(1.43m)
3.0'	5.22	5.3'(1.62m)	9.5'(2.90m)
4.5'	2.23	8.0'(2.44m)	14.2'(4.33m)
6.0'	1.30	10.7'(3.26m)	19.0'(5.79m)
7.5'	0.84	13.3'(4.05m)	23.7'(7.22m)
9.0'	0.58	16.0'(4.88m)	28.4'(8.66m)

0° Spread: 83.3° 90° Spread: 115.3°

PHOTOMETRIC DATA:

L114
6W/FT
30°
3000K Std
344.2 lm
Frosted Lens

Polar Candela Distribution

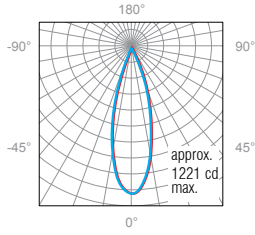

Illuminance at a Distance

	Center Beam FC	Beam Width	
1.5'	498	0.8'(0.24m)	0.8'(0.24m)
3.0'	125	1.6'(0.48m)	1.6'(0.48m)
4.5'	55.3	2.4'(0.73m)	2.4'(0.73m)
6.0'	31.1	3.3'(1.01m)	3.3'(1.01m)
7.5'	19.9	4.1'(1.25m)	4.1'(1.25m)
9.0'	13.8	4.9'(1.49m)	4.9'(1.49m)

0° Spread: 30.3° 90° Spread: 30.2°

L114
6W/FT
60°
3000K Std
322.7 lm
Frosted Lens

Polar Candela Distribution

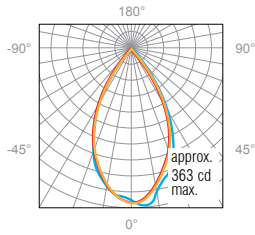

Illuminance at a Distance

	Center Beam FC	Beam Width	
1.5'	156	1.6'(0.5m)	1.6'(0.5m)
3.0'	39	3.2'(1.0m)	3.2'(1.0m)
4.5'	17.3	4.8'(1.5m)	4.8'(1.5m)
6.0'	9.74	6.4'(2.0m)	6.4'(2.0m)
7.5'	6.23	7.9'(2.4m)	8.0'(2.4m)
9.0'	4.99	9.5'(2.9m)	9.6'(2.9m)

0° Spread: 55.8° 90° Spread: 56.2°

L114
6W/FT
120°
3000K Std
351.7lm
Frosted Lens

Polar Candela Distribution

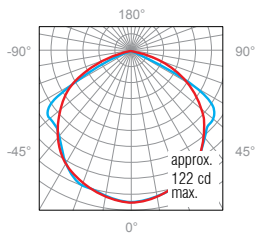

Illuminance at a Distance

	Center Beam FC	Beam Width	
1.5'	54.2	5.3'(1.62m)	4.8'(1.46m)
3.0'	13.5	10.6'(3.23m)	9.5'(2.90m)
4.5'	6.02	15.9'(4.85m)	14.3'(4.36m)
6.0'	3.39	21.3'(6.49m)	19.1'(5.82m)
7.5'	2.17	26.6'(8.11m)	23.9'(7.28m)
9.0'	1.50	31.9'(9.69m)	28.6'(8.72m)

0° Spread: 121.1° 90° Spread: 115.7°

L114
10W/FT
120°
3000K Std
602.5lm
Clear Lens

Polar Candela Distribution

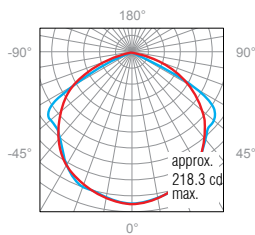

Illuminance at a Distance

	Center Beam FC	Beam Width	
1.5'	96.8	5.0'(1.52m)	4.6'(1.46m)
3.0'	24.2	9.9'(3.02m)	9.1'(2.77m)
4.5'	10.8	14.9'(4.54m)	13.7'(4.18m)
6.0'	6.05	19.9'(6.07m)	18.3'(5.58m)
7.5'	3.87	24.9'(7.59m)	22.9'(6.98m)
9.0'	2.69	29.8'(9.08m)	27.0'(8.23m)

0° Spread: 117.8° 90° Spread: 113.5°

L114
10W/FT
120°
3000K Std
496.1lm
Frosted Lens

Polar Candela Distribution

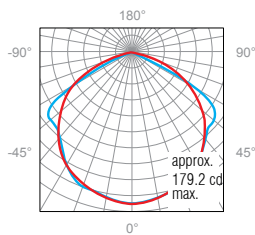

Illuminance at a Distance

	Center Beam FC	Beam Width	
1.5'	79.5	5.1'(1.55m)	4.5'(1.37m)
3.0'	19.9	10.2'(3.11m)	9.1'(2.77m)
4.5'	8.83	15.3'(4.66m)	13.6'(4.15m)
6.0'	4.97	20.4'(6.22m)	18.2'(5.55m)
7.5'	3.18	25.5'(7.77m)	22.7'(6.92m)
9.0'	2.21	30.6'(9.33m)	27.3'(8.32m)

0° Spread: 119.1° 90° Spread: 113.2°