

# EBX-OCT1-C

## OCT1 (Octagonal Aluminum Back Box) with C flange

Outer Diameter: Ø1-7/8" (49mm)

Inner Diameter: Ø1-5/8" (41mm)

In-grade : For ground, ceilings, walls, and stairs

- Wet, Damp, and Dry location

### Components:

1. Plastic Cap
2. Flange - Please see below for flange & material options.
3. Base Plate - Aluminum
4. Box - Die-cast Aluminum

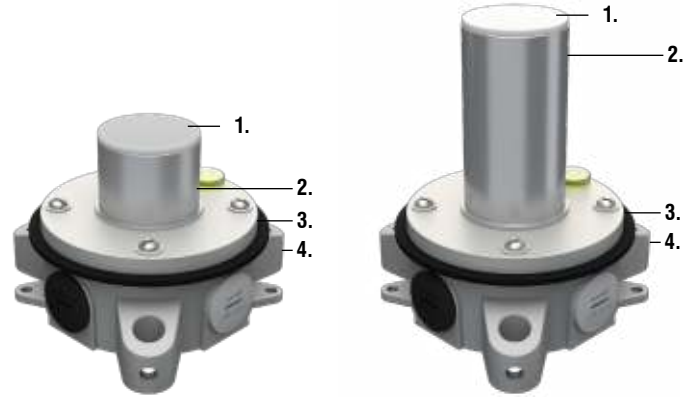

## Flange Options & Dimensions

### Aluminum Back Box with Standard Flange



Aluminum Flange (MA)  
EBX-OCT1-CSMA



Stainless Steel 316 Flange (S6)  
EBX-OCT1-CSS6

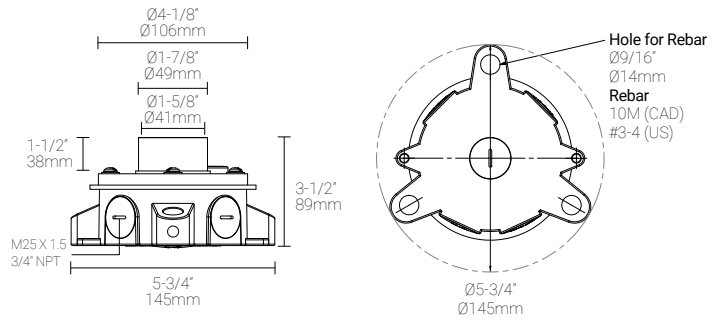

### Aluminum Back Box with Paving Stone Flange



Aluminum Flange (MA)  
EBX-OCT1-CPMA



Stainless Steel 316 Flange (S6)  
EBX-OCT1-CPS6

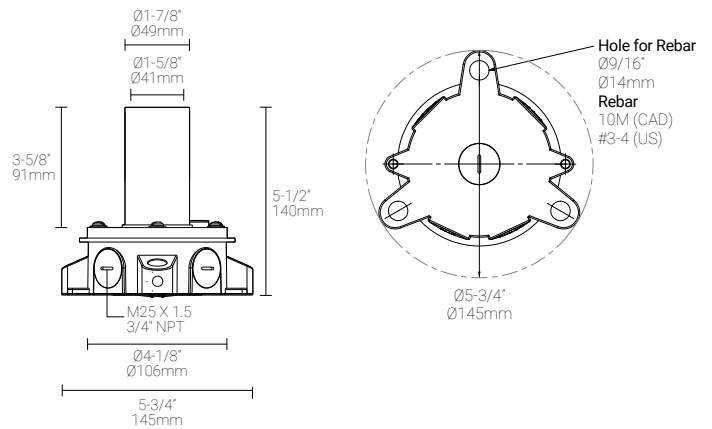

# EBX-OCT1-C

## OCT1 (Octagonal Aluminum Back Box) with C flange

Outer Diameter: Ø1-7/8" (49mm)

















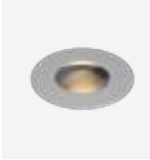

Inner Diameter: Ø1-5/8" (41mm)

In-grade : For ground, ceilings, walls, and stairs

- Wet, Damp, and Dry location



### Compatible Fixtures

					
					
Regular Beam	L01 •	L304 •	L302 •	L310 •	L312 •
					
Half-Shielded	L300 •	L306 •			
					
Single Aperture	L08-S •				
					
Double Aperture	L08-D •				

\* EBX-OCT1-CPS6: Only available with 302(S6) and L306(S6)

\* L310: Back box sold separately

\* L312: Only available with Paving Stone Flange

# EBX-SGB1-C

## SGB1 (MP Lighting Single Gang Box) with C flange

Outer Diameter: Ø1-7/8" (49mm)

Inner Diameter: Ø1-5/8" (41mm)

In-grade : For walls and stairs

• Wet, Damp, and Dry location

### Components:

1. Plastic Cap
2. Flange - Please see below for flange & material options.
3. Base Plate - Aluminum
4. Box - Stainless Steel 304

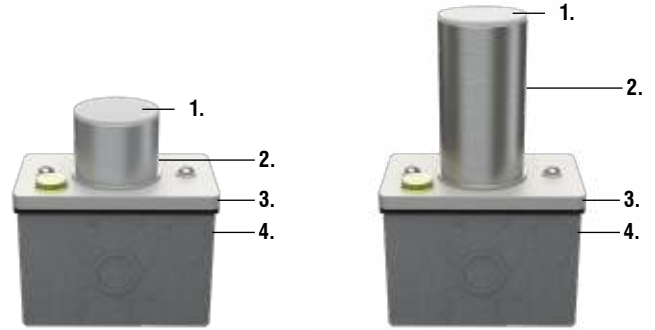

## Flange Options & Dimensions

### MP Lighting Single Gang Box with Standard Flange



Aluminum Flange (MA)  
EBX-SGB1-CSMA

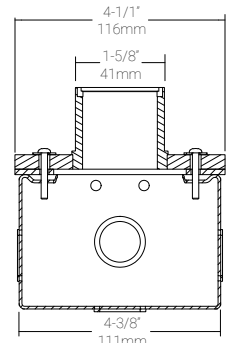
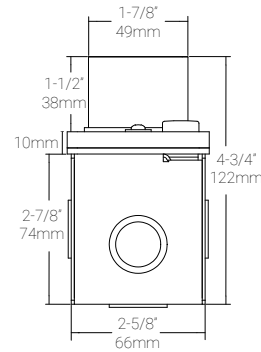
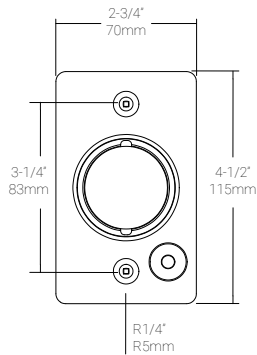

Stainless Steel 316 Flange (S6)  
EBX-SGB1-CSS6

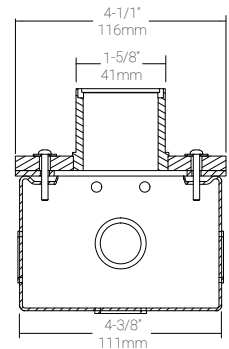
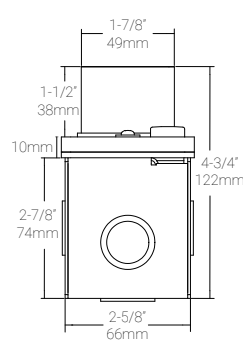
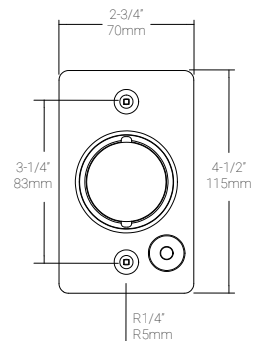

### MP Lighting Single Gang Box with Paving Stone Flange



Stainless Steel 316 Flange (S6)  
EBX-SGB1-CPS6

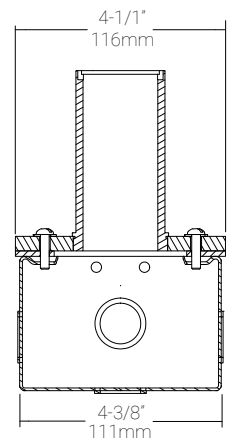
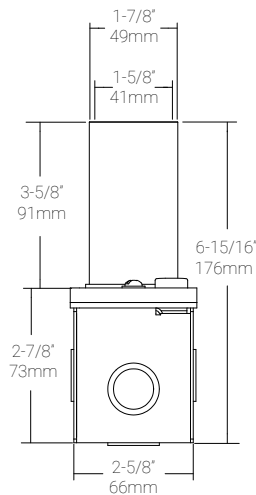
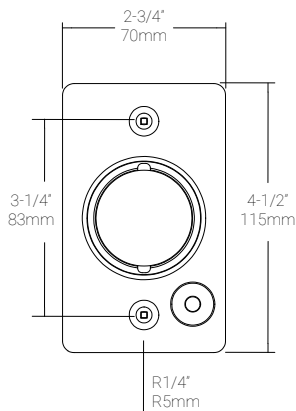

# EBX-SGB1-C

## SGB1 (MP Lighting Single Gang Box) with C flange

Outer Diameter: Ø1-7/8" (49mm)

Inner Diameter: Ø1-5/8" (41mm)

In-grade : For walls and stairs

- Wet, Damp, and Dry location

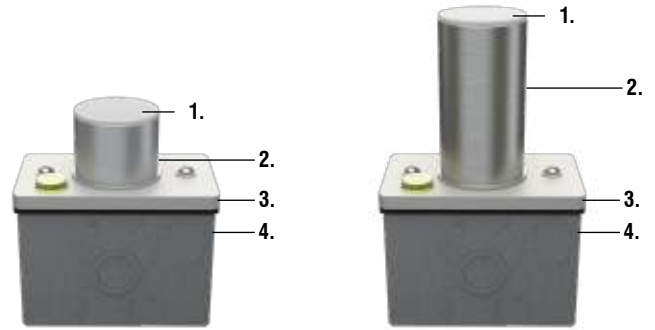

### Compatible Fixtures

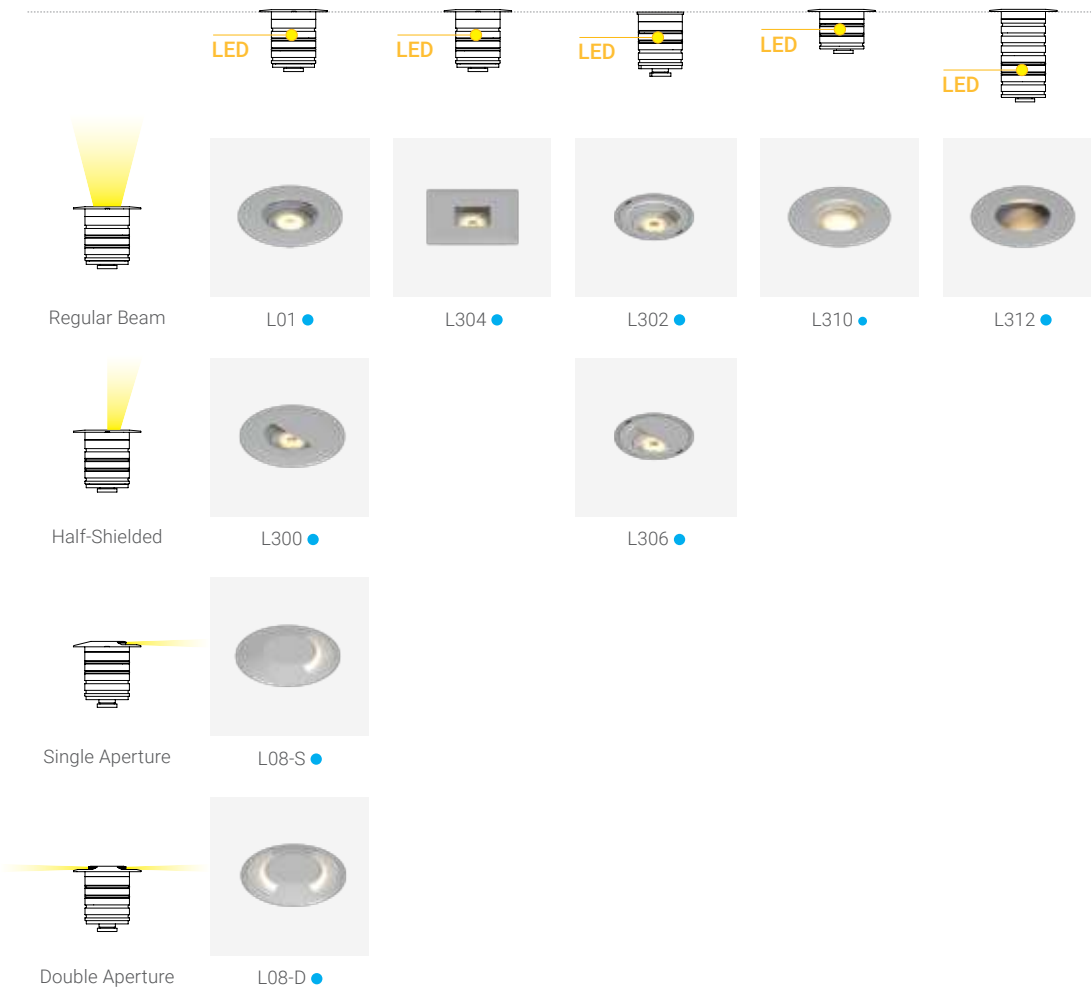

\* L312: Only available with Paving Stone Flange

# EBX-SFD-C

## SFD (Scepter FD Box) with C flange

Outer Diameter: Ø1-7/8" (49mm)

Inner Diameter: Ø1-5/8" (41mm)

In-grade : For walls and stairs

- Wet, Damp, and Dry location

### Components:

1. Plastic Cap
2. Flange - Please see below for flange & material options.
3. Base Plate - Aluminum
4. Box - PVC

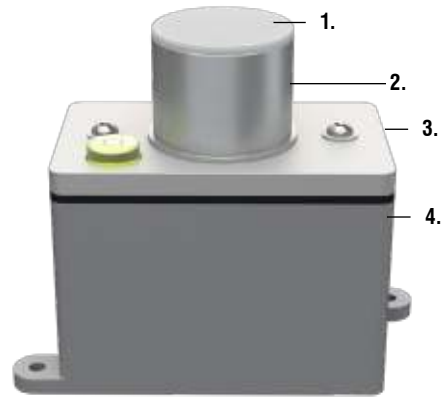

## Flange Options & Dimensions

### Rectangular Back Box with Standard Flange



Aluminum Flange (MA)  
EBX-SFD-CSMA



Stainless Steel 316 Flange (S6)  
EBX-SFD-CSS6



Aluminum Flange (MA)  
EBX-SFD-CPMA



Stainless Steel 316 Flange (S6)  
EBX-SFD-CPS6

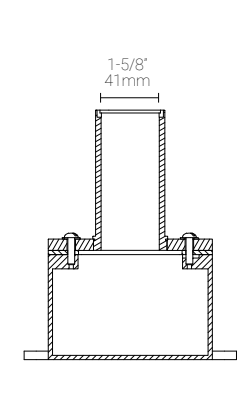
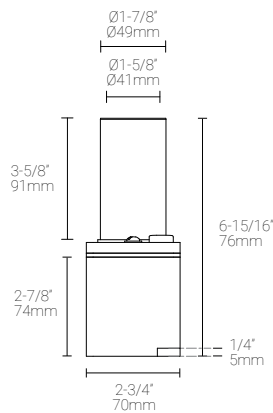
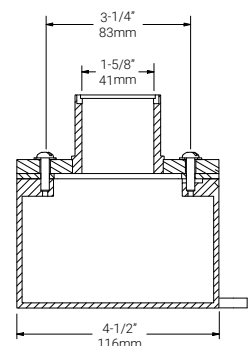
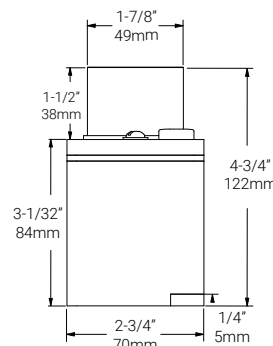
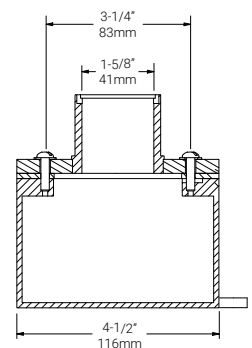
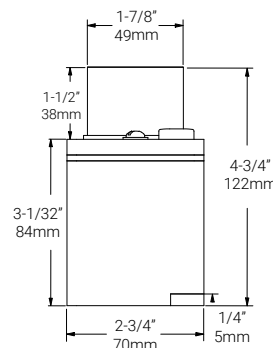

# EBX-SFD-C

**SFD (Scepter FD Box) with C flange**

Outer Diameter: Ø1-7/8" (49mm)

Inner Diameter: Ø1-5/8" (41mm)

In-grade : For walls and stairs

- Wet, Damp, and Dry location

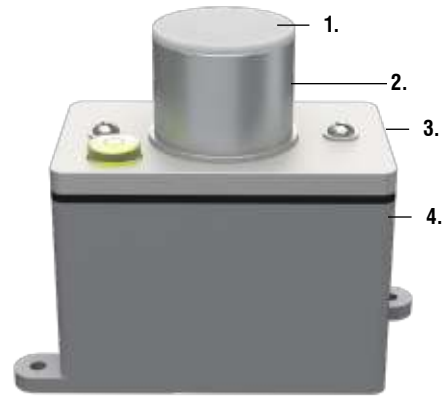

## Compatible Fixtures

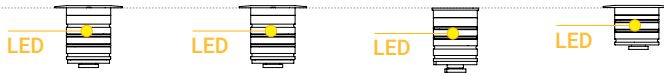

Regular Beam



L01 •

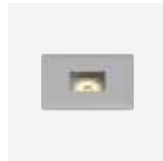

L304 •

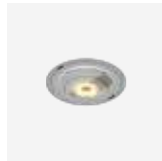

L302 •



L310 •



Half-Shielded

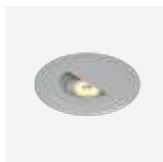

L300 •

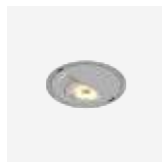

L306 •



Single Aperture



L08-S •



Double Aperture

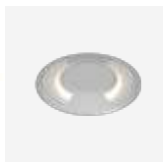

L08-D •

# EBX-OCT1-CPIPE

## OCT1 (Octagonal Aluminum Back Box) with C flange

Outer Diameter: Ø1-7/8" (49mm)

Inner Diameter: Ø1-5/8" (41mm)

In-grade : For ground, ceilings, walls, and stairs

- Wet, Damp, and Dry location

### Components:

1. Plastic Cap
2. Flange - Black PVC, UV stabilized. Compatible with couplings, elbows, t-junction fittings for standard 1-1/2" PVC pipe (outer diameter 1-7/8").
3. Base Plate - Aluminum
4. Box - Die-cast Aluminum



## Flange Options & Dimensions

### Aluminum Back Box with Standard Flange



Aluminum Flange (MA)  
EBX-OCT1-CPIPE

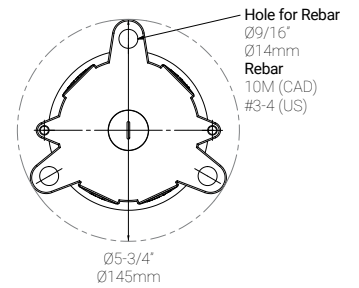
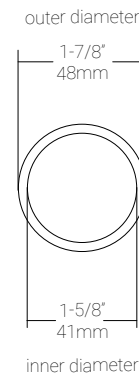
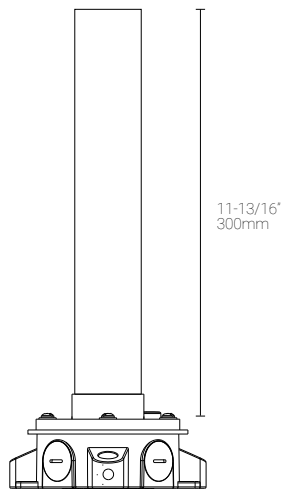

# EBX-OCT1-CPIPE

**OCT1 (Octagonal Aluminum Back Box) with C flange**

Outer Diameter: Ø1-7/8" (49mm)

Inner Diameter: Ø1-5/8" (41mm)

In-grade : For ground, ceilings, walls, and stairs

- Wet, Damp, and Dry location



## Compatible Fixtures

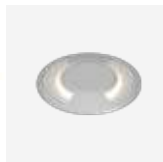
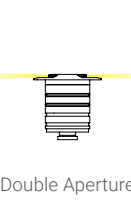
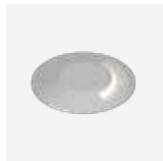
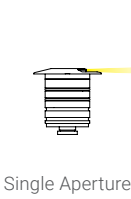
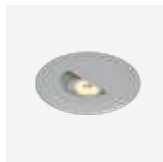
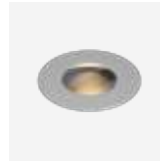
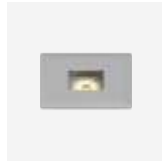



# EBX-SFD-CPIPE

## SFD (Scepter FD Box) with C flange

Outer Diameter: Ø1-7/8" (49mm)

Inner Diameter: Ø1-5/8" (41mm)

In-grade : For ground, ceilings, walls, and stairs

- Wet, Damp, and Dry location

### Components:

1. Plastic Cap
2. Flange - Black PVC, UV stabilized. Compatible with couplings, elbows, t-junction fittings for standard 1-1/2" PVC pipe (outer diameter 1-7/8").
3. Base Plate - Aluminum
4. Box - Die-cast Aluminum

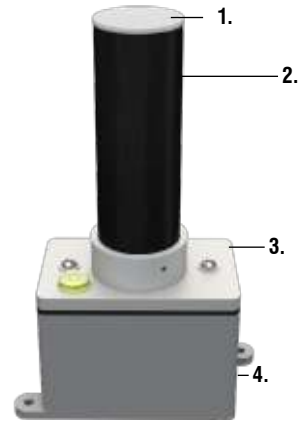

## Flange Options & Dimensions

### Aluminum Back Box with Standard Flange



EBX-SFD-CPIPE

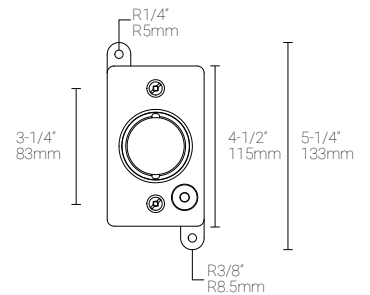
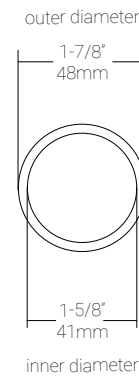
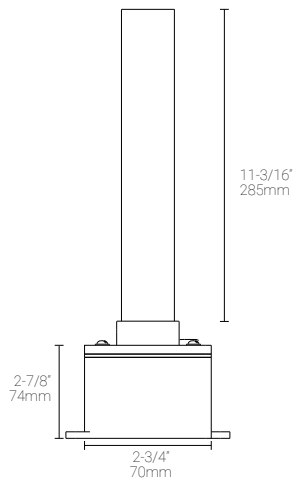

# EBX-SFD-CPIPE

## SFD (Scepter FD Box) with C flange

Outer Diameter: Ø1-7/8" (49mm)

Inner Diameter: Ø1-5/8" (41mm)

In-grade : For ground, ceilings, walls, and stairs

- Wet, Damp, and Dry location

### Components:

1. Plastic Cap
2. Flange - Black PVC, UV stabilized. Compatible with couplings, elbows, t-junction fittings for standard 1-1/2" PVC pipe (outer diameter 1-7/8".
3. Base Plate - Aluminum
4. Box - Die-cast Aluminum



## Compatible Fixtures



Regular Beam



L01 •

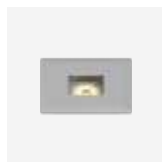

L304 •



L310 •

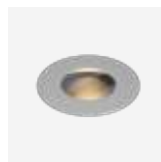

L312 •



Half-Shielded

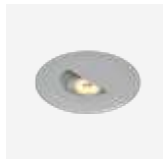

L300 •



Single Aperture



L08-S •



Double Aperture

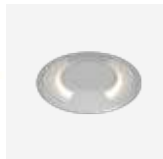

L08-D •

# EBX-OCT2-C

## OCT2 (Octagonal Brass Back Box) with C flange

Outer Diameter: Ø1-7/8" (49mm)

Inner Diameter: Ø1-5/8" (41mm)

In-grade : For ground, ceilings, walls, stairs. Typically used for coastal projects

• Wet, Damp, and Dry location

### Components:

1. Plastic Cap
2. Flange - Please see below for flange & material options.
3. Base Plate - Brass
4. Box - Brass

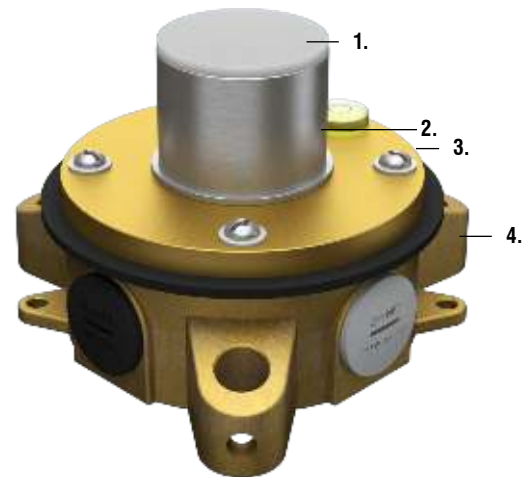

## Flange Options & Dimensions

### Brass Back Box with Standard Flange



Stainless Steel 316 Flange (S6)  
EBX-OCT2-CSS6

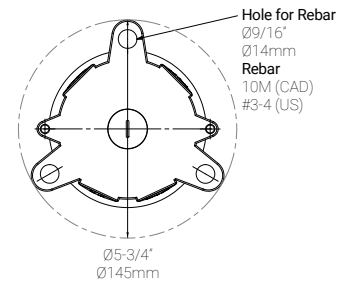
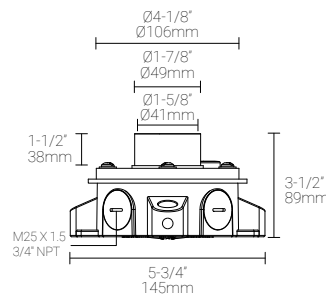

# EBX-OCT2-C

**OCT2 (Octagonal Brass Back Box) with C flange**

Outer Diameter: Ø1-7/8" (49mm)

Inner Diameter: Ø1-5/8" (41mm)

In-grade: For ground, ceilings, walls, stairs, and for coastal projects

- Wet, Damp, and Dry location

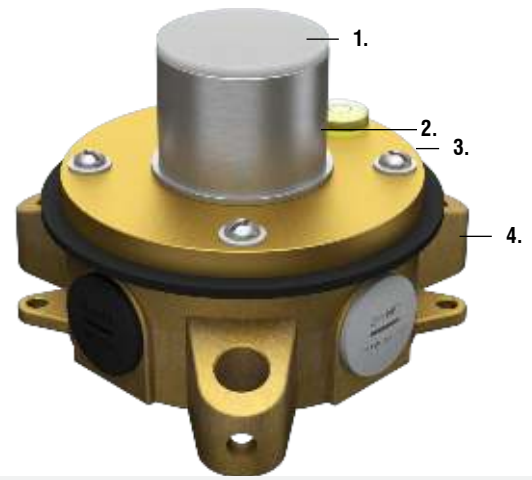

## Compatible Fixtures



Regular Beam



L01 •

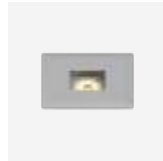

L304 •

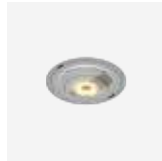

L302 •



L310 •

Half-Shielded

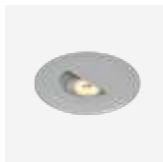

L300 •



L306 •

Single Aperture



L08-S •

Double Aperture

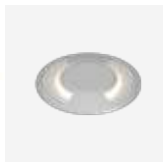

L08-D •

# EBX-SQR1-C

## SQR1 (Square Stainless Steel & Brass Back Box) with C flange

Outer Diameter: Ø1-7/8" (49mm)

Inner Diameter: Ø1-5/8" (41mm)

In-grade | Submersed under water up to 10' (3m) depth.

- Underwater/Swimming Pool Certified

### Components:

1. Plastic Cap
2. Flange - Stainless Steel 316
3. Base Plate - Brass
4. Box - Stainless Steel 304

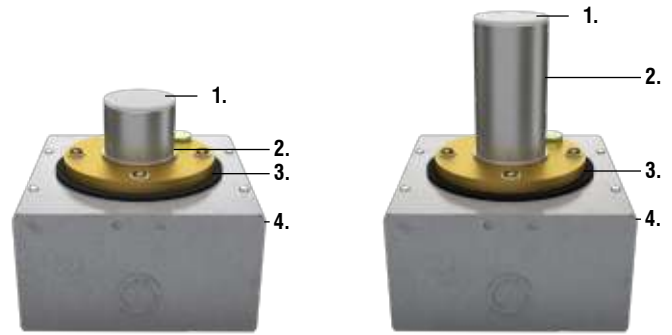

## Flange Options & Dimensions

### Stainless Steel 304 Back Box with Standard Flange



Stainless Steel 316 Flange (S6)  
EBX-SQR1-CSS6

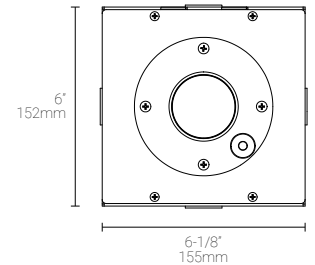
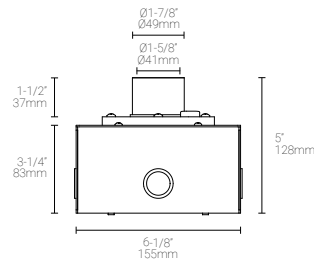

### Stainless Steel 304 Back Box with Paving Stone Flange



Stainless Steel 316 Flange (S6)  
EBX-SQR1-CPS6

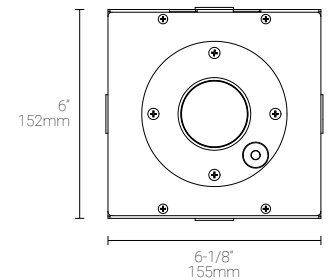
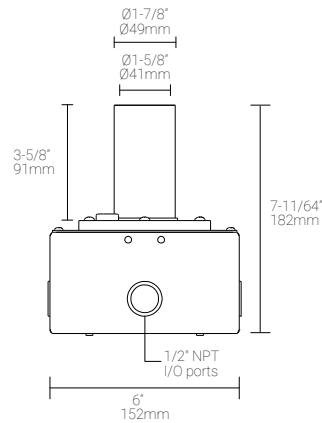

# EBX-SQR1-C

**SQR1 (Square Stainless Steel & Brass Back Box) with C flange**

Outer Diameter: Ø1-7/8" (49mm)

Inner Diameter: Ø1-5/8" (41mm)

In-grade | Submersed under water up to 10' (3m) depth.

- Underwater/Swimming Pool Certified

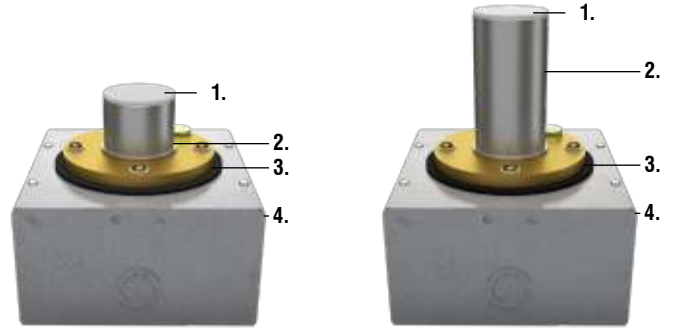

## Compatible Fixtures

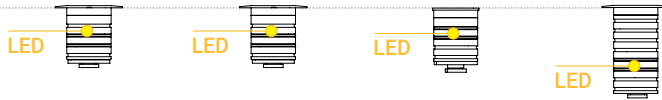

Regular Beam

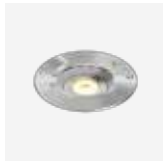

U01 ●

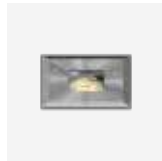

U304 ●

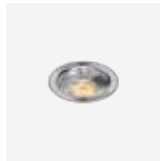

U302 ●



U312 ●



Half-Shielded

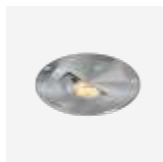

U300 ●

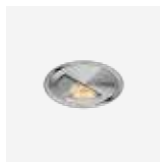

U306 ●



Single Aperture

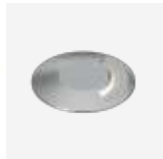

U08-S ●



Double Aperture

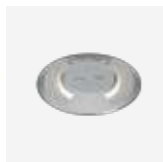

U08-D ●

\* U312: Only available with Paving Stone Flange