

# L09

LED In-grade Indoor

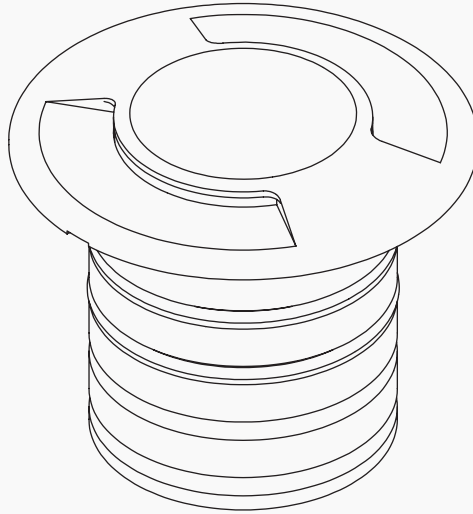

Wall Mount  
Standard Flange

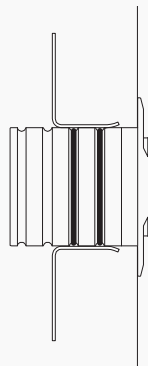

# L09

LED In-grade Indoor

## Parts

- Flange FLG-L02-ZP x 1
- LED fixture x 1
- Wire connectors x 2
- O-rings x 2
- Lubrication grease — Included
- Back box — Not included

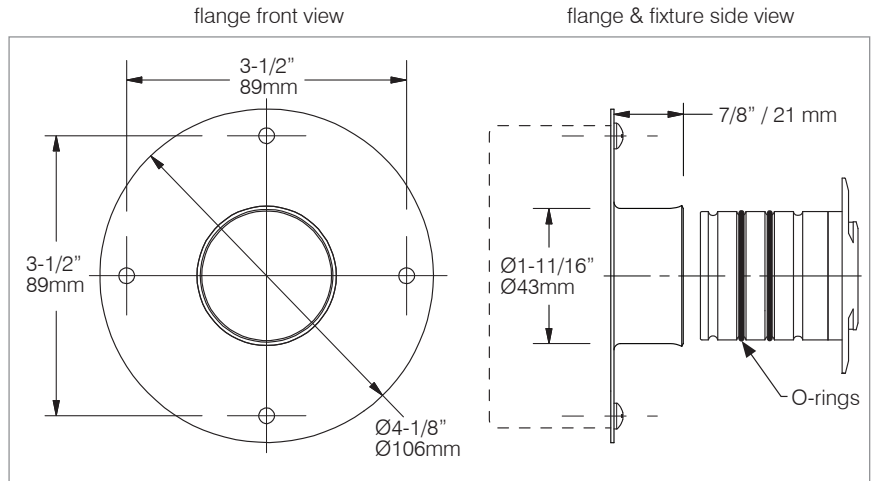

1) Mount flange to electrical box so flange is flush with the face of surface or setback 1/8" (3mm) max.

2) Connect fixture wires to low voltage wiring (remote LED driver constant current). The power to the driver must be off while wiring LED fixtures to drivers. *\*Connecting LEDs to a live driver will cause LEDs to Fail.*

3) Cut Ø1-5/8" (Ø41mm) hole in surface material to fit fixture.

4) APPLY GREASE (lubrication grease) to bottom of fixture on o-rings and inside of flange, for proper insertion and removal of fixture. Inside of flange must be clean before applying lubrication grease.

5) With a twisting back and forth motion insert fixture into flange.

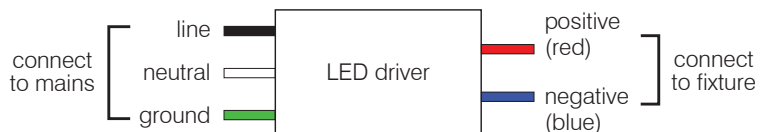
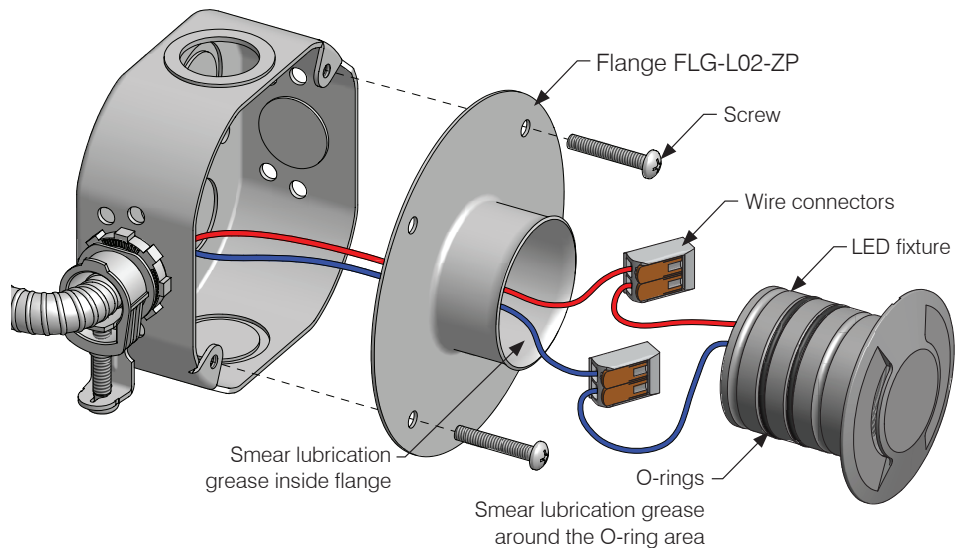
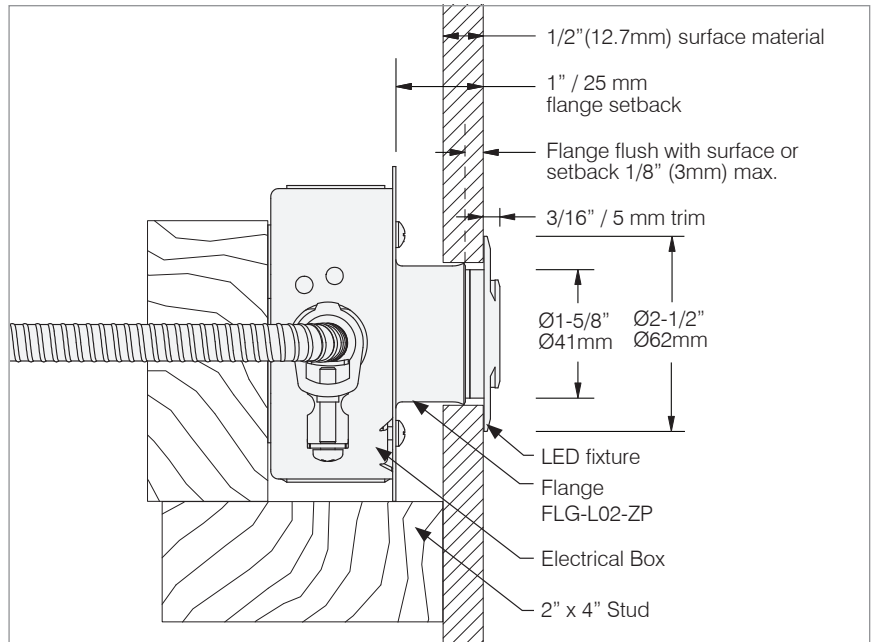

## IMPORTANT SAFETY INSTRUCTIONS

KEEP THESE INSTALLATION INSTRUCTIONS

(Including General and Additional Markings for Fixtures)

(FOR MP LIGHTING LED LUMINAIRES, CLASS 3402-xx)

Installation instructions

1. The grounding installation shall be done in accordance with CEC-Part 1.
2. WARNING: RISK OF FIRE OR ELECTRIC SHOCK: DO NOT MAKE OR ALTER ANY OPENINGS IN THE COMPARTMENT OF WIRING OR ELECTRICAL COMPONENTS DURING INSTALLATION. DO NOT ALTER OR ADD BALLASTS, OR ANY OTHER ELECTRICAL COMPONENTS.
3. INSTALLATION AND USE OF THIS FIXTURE MOUNTING ASSEMBLY REQUIRES A PERSON FAMILIAR WITH THE CONSTRUCTION AND OPERATION OF LUMINAIRE ELECTRICAL SYSTEMS AND THE HAZARD INVOLVED, IF NOT QUALIFIED, DO NOT ATTEMPT INSTALLATION. CONTACT A QUALIFIED ELECTRICIAN.
4. DRY LOCATIONS ONLY
5. TURN OFF POWER BEFORE INSTALLATION.
6. KEEP THESE INSTALLATION INSTRUCTIONS.

## CONSIGNES DE SÉCURITÉ IMPORTANTES

CONSERVER CES INSTRUCTIONS D'INSTALLATION

(Dont le général et marques supplémentaires pour les appareils)

(Pour les luminaires LED MP D'ÉCLAIRAGE , CLASS 3402 -xx )

Les instructions d'installation

1. L'installation de mise à la terre doit être fait en conformité avec CEC Partie 1.
2. AVERTISSEMENT : RISQUE D'INCENDIE OU D'ÉLECTROCUTION : NE PAS FAIRE OU MODIFIER DES OUVERTURES DANS LE COMPARTIMENT DE CÂBLAGE OU DE COMPOSANTS ÉLECTRIQUES LORS DE L'INSTALLATION. NE PAS MODIFIER OU AJOUTER DES BALLASTS, OU AUTRES COMPOSANTS ÉLECTRIQUES
3. CE PRODUIT DOIT ÊTRE INSTALLÉ SELON LE CODE D'INSTALLATION PERTINENT, PAR UNE PERSONNE QUI CONNAÎT BIEN LE PRODUIT ET SON FONCTIONNEMENT AINSI QUE LES RISQUES INHÉRENTS. CONSULTER UN ÉLECTRICIEN QUALIFIÉ.
4. POUR EMPLACEMENTS SECS SEULEMENT
5. COUPER LE COURANT AVANT L'INSTALLATION.
6. CONSERVEZ CES INSTRUCTIONS.