

L137

EXTERIOR | INTERIOR

Surface Mount Downlight | For ceilings, counters & cabinets

Damp and Dry Location | Photocell | Motion Sensor

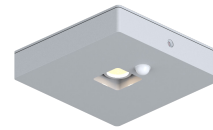

Ordering Information

Clear Form

Date : _____

Project : _____

Type : _____

Quantity : _____

Note : _____

Specifications

Luminaire | Example Code: L137-8-P-W30H-S-B-MA

Product	Version	Sensor ¹	CCT & CRI ²	Beam Angle	Surface-Mount Box ³ (optional)	Finish
L137	8					MA
	8 8W	P photocell sensor M motion sensor B both sensors	W22S 2200K 80+ W27H 2700K 90+ W30H 3000K 90+ W35H 3500K 90+	S spot 12° N narrow flood 30°	B surface-mount box	MA matte clear anodized

Important Notes

Specification

- Photocell sensor hole will be always on the housing whether the fixture uses it or not.
- Refer to pg.02 - for Light Quality & Colour Consistency details.
- Refer to pg.03-04 - for images and installation guide. Surface mount box comes bare (no finishes available) with matte gray plugs. Can be painted on-site to match desired surface.

Warranty Notes & Disclaimer

Malfunction and damage to product due to incompatible dimming system or misuse will not be covered under warranty. Consult MP Lighting for recommended drivers. If the fixture has an option to be installed with a dimming control system, consult a dimming system manufacturer with minimum load before installing. MP Lighting reserves the right, at its sole discretion, at any time and without notice, to make design changes to any of our products. Consult MP Lighting website for most updated documentation.

L137

EXTERIOR | INTERIOR

Surface Mount Downlight | For ceilings, counters & cabinets

Damp and Dry location | Photocell | Motion Sensor

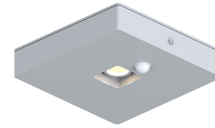

Performance

Wattage	Forward Current	Power Consumption Budget per fixture (including driver)	LED output (Source)	Fixture Output (Delivered)
8W	700mA	9W	880 lm	273-283 lm

Application

Environment	Damp and Dry Location approved. IP 62
Mounting	Mounts with built-in surface-mount box (optional) or mounts to a 4" octagonal box (supplied by others)

Electrical

Electrical	Integral LED drivers (120V DC input, non-dimmable, constant voltage output)
Control	On/off control

Luminaire Construction

LED Light Source	W22H = CCT: 2200K, CRI (Ra): 90+, Colour Consistency: 3SDCM W27H = CCT: 2700K, CRI (Ra): 90+, Colour Consistency: 2SDCM W30H = CCT: 3000K, CRI (Ra): 90+, Colour Consistency: 2SDCM W35H = CCT: 3500K, CRI (Ra): 90+, Colour Consistency: 2SDCM
Weight	N/A
Material	Fixture: machined marine-grade aluminum
Supplied with	Standard installation housing: Comes with an adapter plate, two #8-32 screws, and wire nuts OR with the optional Surface mount back box (B).
Warranty & LED Life	5 years limited warranty Estimated useful life of LED is 50,000 hours.

Ordered Separately

System Components	Power supplies: alternate remote driver Please consult factory or visit Recommended Drivers for available driver options.
-------------------	---

Mounting Options & Dimensions

LED Fixture Dimensions

Fixture

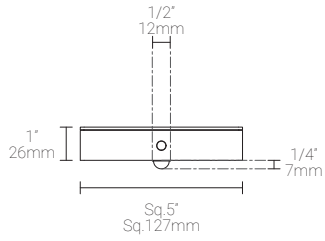

Top View

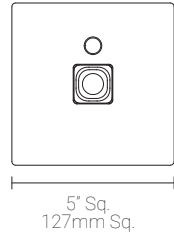

3D View

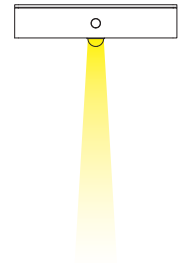
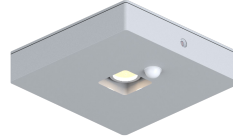

LED Fixture Dimensions | with B, surface-mount box (optional)

Fixture

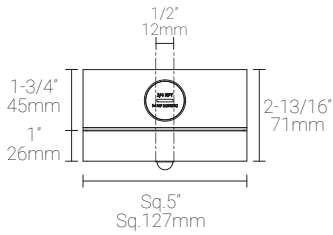

Bottom View

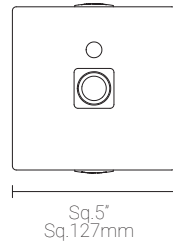

3D View

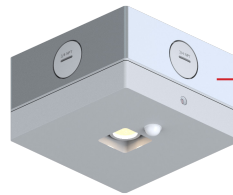

Beam

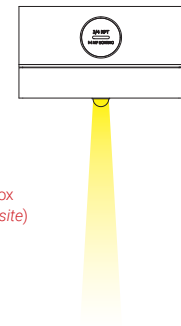

Installation | with standard 4" octagonal back box (supplied by others)

Fixture

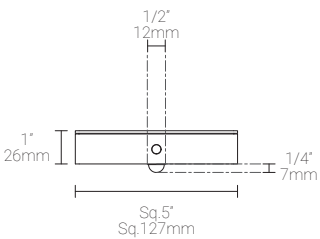

Ceiling mounted

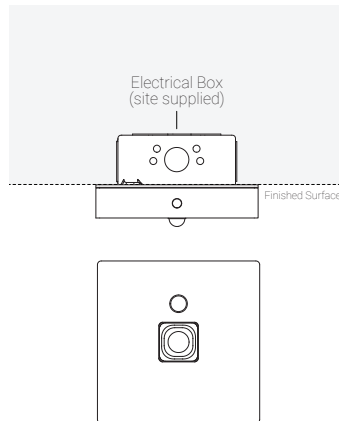

Installation | with B, surface-mount box (optional)

Fixture

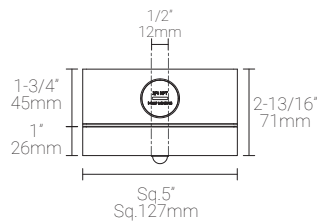

Ceiling mounted

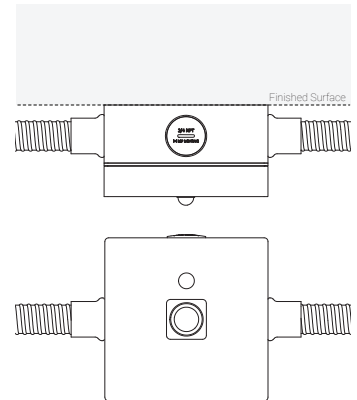

4W, 3000K, 90+ CRI

Polar Candela Distribution

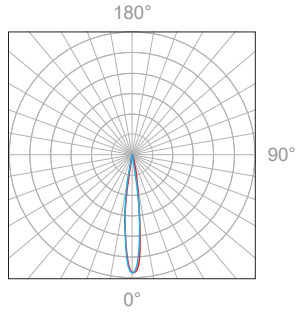

Beam Width: 12°



Illuminance at a Distance

Distance		Center Beam fc	Beam Width			
3.0ft	0.91m	281fc	1.2ft	0.36m	1.2ft	0.36m
6.0ft	1.83m	70.3fc	2.5ft	0.76m	2.5ft	0.76m
9.0ft	2.74m	31.2fc	3.7ft	1.12m	3.7ft	1.12m
12.0ft	3.66m	17.6fc	4.9ft	1.49m	5.0ft	1.52m
15.0ft	4.57m	11.2fc	6.2ft	1.89m	6.2ft	1.89m
18.0ft	5.49m	7.81fc	7.4ft	2.25m	7.5ft	2.28m

Delivered Lumen: 581.9 lm
 ■ Vertical Beam Spread: 23.3°
 ■ Horizontal Beam Spread: 23.4°

Polar Candela Distribution

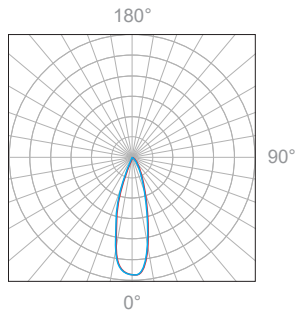

Beam Width: 30°

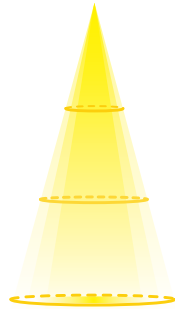

Illuminance at a Distance

Distance		Center Beam fc	Beam Width			
3.0ft	0.91m	263fc	1.4ft	0.43m	1.3ft	0.40m
6.0ft	1.83m	65.7fc	2.8ft	0.85m	2.7ft	0.88m
9.0ft	2.74m	29.2fc	4.3ft	1.31m	4.0ft	1.21m
12.0ft	3.66m	16.4fc	5.7ft	1.73m	5.3ft	1.61m
15.0ft	4.57m	10.5fc	7.1ft	2.16m	6.6ft	2.01m
18.0ft	5.49m	7.29fc	8.5ft	2.59m	8.0ft	2.43m

Delivered Lumen: 604.5 lm
 ■ Vertical Beam Spread: 26.7°
 ■ Horizontal Beam Spread: 25.0°