

L225SF-M

INTERIOR

Spotlight | For ceilings, walls & counters

● Dry location



Ordering Information Clear Form

Date : _____ Project : _____ Type : _____	Quantity : _____ Note : _____
---	----------------------------------

Specifications

Luminaire | Example Code: L225-SF-M-8-W30H-S-HLD-ELB4-2-MA

For Beam Angle options: Spot (12°), Narrow Flood (30°) & Flood (48°)

Product	Canopy	Size	Version	CCT & CRI	Beam Angle	Accessories-Holder ² (optional)	Accessories-Louver (optional)	Stem Length ³	Finish
L225	SF	M							MA
	SF single rail flush wall	M medium	4 4W 8 8W	W27H 2700K 90+ W30H 3000K 90+	S spot 12° N narrow flood 30° F flood 48°	HLD louver holder	ELB4 eggcrate louver, black anodized	2 2" (51mm) X custom length	MA matte clear anodized

For Beam Angle options: Super Spot (7°)

Product	Canopy	Size	Version	CCT & CRI	Beam Angle ¹	Accessories-Holder ² (optional)	Accessories-Louver (optional)	Stem Length ³	Finish
L225	SF	M			SS	HLD			MA
	SF single rail flush wall	M medium	4 4W 8 8W	W27H 2700K 90+ W30H 3000K 90+	SS super spot 7°	HLD louver holder	ELB4 eggcrate louver, black anodized	2 2" (51mm) X custom length	MA matte clear anodized

System Components (Ordered Separately)

Remote Driver : _____

* Consult MP Lighting Website or Factory.

Important Notes

Specification

1. HLD is required for SS (super spot, 7°) lens
2. HLD is required for louvers or other accessories supplied on site.
3. 1" (25mm) increments to maximum of 6' (152mm).

Warranty Notes & Disclaimer

Malfunction and damage to product due to incompatible dimming system or misuse will not be covered under warranty. Consult MP Lighting for recommended drivers. If the fixture has an option to be installed with a dimming control system, consult a dimming system manufacturer with minimum load before installing. MP Lighting reserves the right, at its sole discretion, at any time and without notice, to make design changes to any of our products. Consult MP Lighting website for most updated documentation.

L225SF-M

INTERIOR

Spotlight | For ceilings, walls & counters

- Dry location

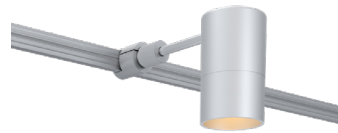

Performance

Wattage	Forward Current	Power Consumption Budget per fixture (including driver)	LED output (Source)	Fixture Output (Delivered)
4W	350mA	4W	440 lm	208-261 lm
8W	700mA	8W	880 lm	371-433 lm

Application

Environment	Dry Location approved. IP 20.
Mounting	Rotatable and easy to position. Designed for use on MP single rail flush wall system (sold separately).

Electrical

Power Supplies	Remote LED drivers (100-277V AC input, constant voltage output): Fixtures to be wired in parallel.
Control	On/off control Dimming: ELV or 0-10V dimming with appropriate drivers Other options (consult factory): TRIAC/MLV, DMX, DALI, Casambi, Power over Ethernet

Luminaire Construction

LED Light Source	Colour Consistency: 2-step MacAdam: 2700K, 3000K, 90+ CRI
Weight	N/A
Material	Fixture: machined marine-grade aluminum
Supplied with	Standard installation housing: Comes with a connector cap.
Warranty & LED Life	5 years limited warranty Estimated useful life of LED is 50,000 hours.

Ordered Separately

System Components	Power supplies: remote driver Please consult factory or visit Recommended Drivers for available driver options.
-------------------	---

Mounting Options & Dimensions

LED Fixture Dimensions

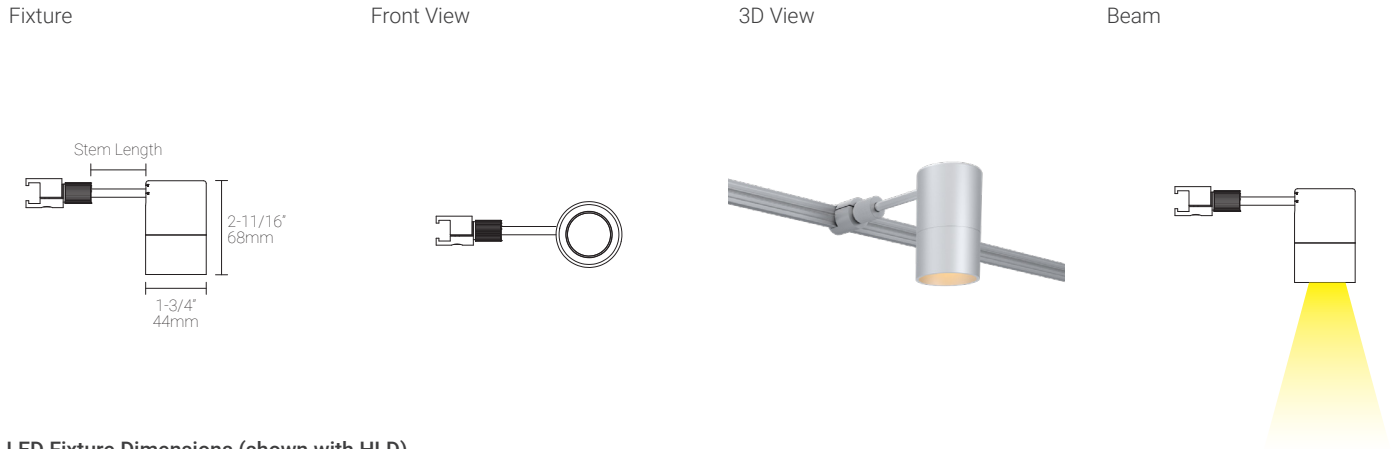

LED Fixture Dimensions (shown with HLD)

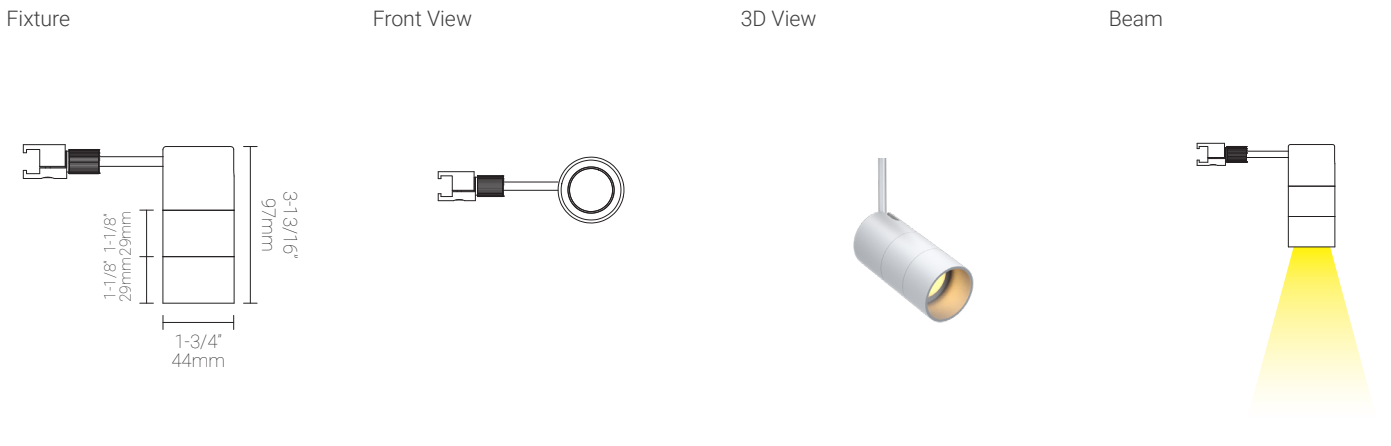

* Shown with C21 canopy

Appendix

Aluminum Finish



MA matte clear anodized

Accessories



MA matte clear anodized

Polar Candela Distribution

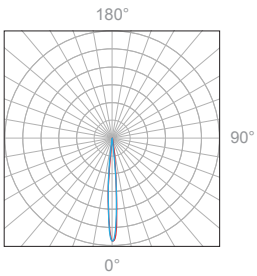

Beam Width: 7°



Illuminance at a Distance

Distance		Center Beam fc	Beam Width			
3.0ft	0.91m	352fc	0.5ft	0.15m	0.5ft	0.15m
6.0ft	1.83m	88fc	1.0ft	0.30m	1.0ft	0.30m
9.0ft	2.74m	39.1fc	1.6ft	0.49m	1.6ft	0.49m
12.0ft	3.66m	22fc	2.1ft	0.64m	2.1ft	0.64m
15.0ft	4.57m	14.1fc	2.6ft	0.79m	2.6ft	0.79m
18.0ft	5.49m	9.78fc	3.1ft	0.94m	3.1ft	0.94m

Delivered Lumen: 208 lm
 ■ Vertical Beam Spread: 9.9°
 ■ Horizontal Beam Spread: 9.9°

Polar Candela Distribution

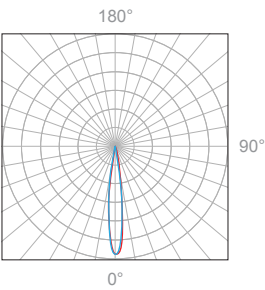

Beam Width: 12°



Illuminance at a Distance

Distance		Center Beam fc	Beam Width			
3.0ft	0.91m	180.3fc	1.0ft	0.30m	1.0ft	0.30m
6.0ft	1.83m	30.9fc	2.1ft	0.64m	2.1ft	0.64m
9.0ft	2.74m	19.2fc	3.1ft	0.94m	3.1ft	0.94m
12.0ft	3.66m	10.7fc	4.1ft	1.25m	4.1ft	1.25m
15.0ft	4.57m	7.3fc	5.2ft	1.58m	5.2ft	1.58m
18.0ft	5.49m	5fc	6.2ft	1.89m	6.2ft	1.89m

Delivered Lumen: 261 lm
 ■ Vertical Beam Spread: 19.5°
 ■ Horizontal Beam Spread: 19.5°

Polar Candela Distribution

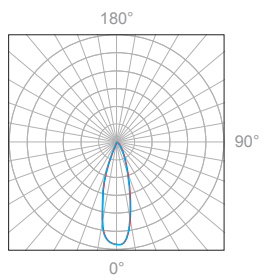

Beam Width: 30°

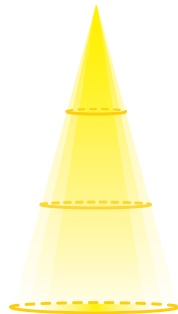

Illuminance at a Distance

Distance		Center Beam fc	Beam Width			
3.0ft	0.91m	114.2fc	1.4ft	0.43m	1.4ft	0.43m
6.0ft	1.83m	28.8fc	2.9ft	0.88m	2.9ft	0.88m
9.0ft	2.74m	12.8fc	4.3ft	1.31m	4.3ft	1.31m
12.0ft	3.66m	7.5fc	5.7ft	1.74m	5.7ft	1.74m
15.0ft	4.57m	4.8fc	7.2ft	2.19m	7.2ft	2.19m
18.0ft	5.49m	3.4fc	8.6ft	2.62m	8.6ft	2.62m

Delivered Lumen: 251 lm
 ■ Vertical Beam Spread: 26.9°
 ■ Horizontal Beam Spread: 26.9°

Polar Candela Distribution

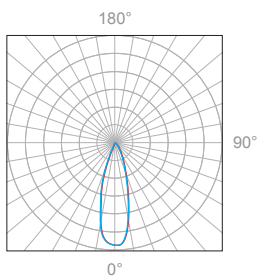

Beam Width: 48°

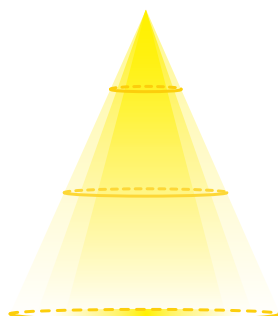

Illuminance at a Distance

Distance		Center Beam fc	Beam Width			
3.0ft	0.91m	45.9fc	2.6ft	0.79m	2.6ft	0.79m
6.0ft	1.83m	11.7fc	5.3ft	1.62m	5.3ft	1.62m
9.0ft	2.74m	5.2fc	7.9ft	2.41m	7.9ft	2.41m
12.0ft	3.66m	3fc	10.6ft	3.23m	10.6ft	3.23m
15.0ft	4.57m	2fc	13.2ft	4.02m	13.2ft	4.02m
18.0ft	5.49m	1.6fc	15.9ft	4.85m	15.9ft	4.85m

Delivered Lumen: 224 lm
 ■ Vertical Beam Spread: 47.6°
 ■ Horizontal Beam Spread: 47.6°

8W, 3000K, 90+ CRI

Polar Candela Distribution

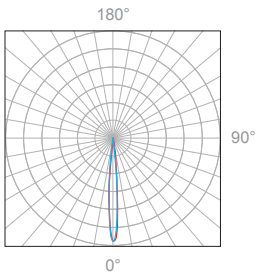

Beam Width: 7°



Illuminance at a Distance

Distance		Center Beam fc	Beam Width			
3.0ft	0.91m	587fc	1.0ft	0.30m	1.0ft	0.30m
6.0ft	1.83m	147fc	2.1ft	0.64m	2.1ft	0.64m
9.0ft	2.74m	65.2fc	3.1ft	0.94m	3.1ft	0.94m
12.0ft	3.66m	36.7fc	4.1ft	1.25m	4.1ft	1.25m
15.0ft	4.57m	23.5fc	5.2ft	1.58m	5.2ft	1.58m
18.0ft	5.49m	16.3fc	6.2ft	1.89m	6.2ft	1.89m

Delivered Lumen: 347 lm
■ Vertical Beam Spread: 9.9°
■ Horizontal Beam Spread: 9.9°

Polar Candela Distribution

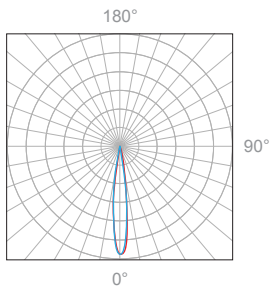

Beam Width: 12°



Illuminance at a Distance

Distance		Center Beam fc	Beam Width			
3.0ft	0.91m	328.6fc	1.0ft	0.30m	1.0ft	0.30m
6.0ft	1.83m	79fc	2.1ft	0.64m	2.1ft	0.64m
9.0ft	2.74m	35.2fc	3.1ft	0.94m	3.1ft	0.94m
12.0ft	3.66m	19.2fc	4.1ft	1.25m	4.1ft	1.25m
15.0ft	4.57m	12.8fc	5.2ft	1.58m	5.2ft	1.58m
18.0ft	5.49m	9.1fc	6.2ft	1.89m	6.2ft	1.89m

Delivered Lumen: 433 lm
■ Vertical Beam Spread: 19.5°
■ Horizontal Beam Spread: 19.5°

Polar Candela Distribution

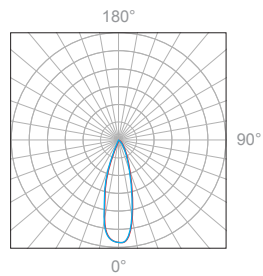

Beam Width: 30°

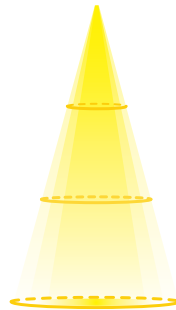

Illuminance at a Distance

Distance		Center Beam fc	Beam Width			
3.0ft	0.91m	202.7fc	1.4ft	0.43m	1.4ft	0.43m
6.0ft	1.83m	50.1fc	2.9ft	0.88m	2.9ft	0.88m
9.0ft	2.74m	21.3fc	4.3ft	1.31m	4.3ft	1.31m
12.0ft	3.66m	11.7fc	5.7ft	1.74m	5.7ft	1.74m
15.0ft	4.57m	8.2fc	7.2ft	2.19m	7.2ft	2.19m
18.0ft	5.49m	6.3fc	8.6ft	2.62m	8.6ft	2.62m

Delivered Lumen: 418 lm
■ Vertical Beam Spread: 26.9°
■ Horizontal Beam Spread: 26.9°

Polar Candela Distribution

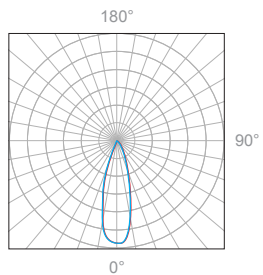

Beam Width: 48°

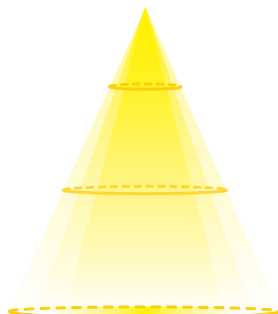

Illuminance at a Distance

Distance		Center Beam fc	Beam Width			
3.0ft	0.91m	75.7fc	2.6ft	0.79m	2.6ft	0.79m
6.0ft	1.83m	19.2fc	5.3ft	1.62m	5.3ft	1.62m
9.0ft	2.74m	8.5fc	7.9ft	2.41m	7.9ft	2.41m
12.0ft	3.66m	4.9fc	10.6ft	3.23m	10.6ft	3.23m
15.0ft	4.57m	3.3fc	13.2ft	4.02m	13.2ft	4.02m
18.0ft	5.49m	2.3fc	15.9ft	4.85m	15.9ft	4.85m

Delivered Lumen: 372 lm
■ Vertical Beam Spread: 47.6°
■ Horizontal Beam Spread: 47.6°