

L228W-M

INTERIOR
Wall light

● Dry location

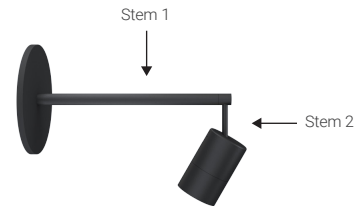

Ordering Information

Clear Form

Date : _____

Quantity : _____

Project : _____

Note : _____

Type : _____

Specifications

Luminaire | Example Code: L228W-W22-M-4-W30H-S-9-A-BA

Product	Canopy	Spotlight Size	Wattage	CCT & CRI ¹	Beam Angle	Stem 1 Length ²	Stem 2 Length ³	Finish
L228W	W22	M						
	W22	M medium	4 4W 8 8W	W27H 2700K 90+ W30H 3000K 90+ WD warm dimming ²	SS super spot 7° S spot 12° N narrow flood 30° F flood 48°	9 9-1/4" (235mm) X custom length	A 1/2" (13mm) X custom length	MA matte clear anodized BA black anodized

System Components (Ordered Separately)

Remote Driver : _____

* Consult MP Lighting Website or Factory.

Important Notes

Specification

1. Refer to pg.2 - for Light Quality & Colour Consistency details.
2. Warm Dimming only available with 6W and Narrow Flood (30°) beam angle.
3. Maximun Length: 2' (609mm), 1" (25mm) increments.
4. Maximun Length: 6' (152m), 1" (25mm) increments.

Warranty Notes & Disclaimer

Malfunction and damage to product due to incompatible dimming system or misuse will not be covered under warranty. Consult MP Lighting for recommended drivers. If the fixture has an option to be installed with a dimming control system, consult a dimming system manufacturer with minimum load before installing. MP Lighting reserves the right, at its sole discretion, at any time and without notice, to make design changes to any of our products. Consult MP Lighting website for most updated documentation.

L228W-M

INTERIOR
Wall light

● Dry location

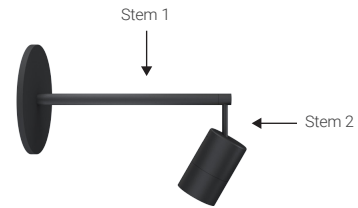

Performance

Wattage	Forward Current	Power Consumption Budget per fixture (including driver)	LED output (Source)	Fixture Output (Delivered)
4W	350mA	4W	440 lm	81-261 lm
8W	700mA	8W	880 lm	141.4-433 lm

Application

Environment	Dry Location approved. IP 20.
Mounting	Mounts to a 4" octagonal box using the mounting canopy.

Electrical

Power Supplies	Remote LED drivers (120-277V AC input, constant voltage output): Fixtures to be wired in parallel.
Control	On/off control Dimming: ELV or 0-10V dimming with appropriate drivers Other options (consult factory): TRIAC/MLV, DMX, DALI, Casambi, Power over Ethernet

Luminaire Construction

LED Light Source	W27H = CCT: 2700K, CRI (Ra): 90+, Colour Consistency: 2SDCM W30H = CCT: 3000K, CRI (Ra): 90+, Colour Consistency: 2SDCM
Weight	N/A
Material	Fixture: machined marine-grade aluminum
Supplied with	Standard installation housing: Comes with a canopy, a universal crossbar, two hex socket head screws, two wire-nuts, and an allen key.
Warranty & LED Life	5 years limited warranty Estimated useful life of LED is 50,000 hours.

Ordered Separately

System Components	Power supplies: remote driver Please consult factory or visit Recommended Drivers for available driver options.
-------------------	-------------------------------------------------------------------------------------------------------------------------------------------

Mounting Options & Dimensions

LED Fixture Dimensions

Fixture

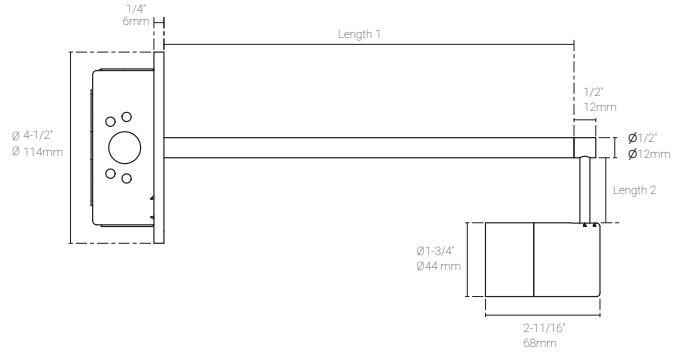

Front View

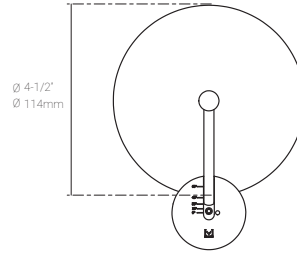

3D View



Appendix

Aluminum Finishes

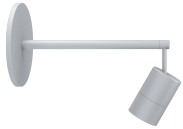

MA matte clear anodized



BA black anodized

4W, 3000K, 90+ CRI

Polar Candela Distribution

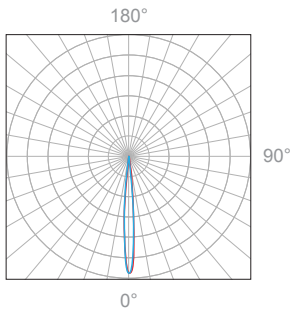

Beam Width: 7°



Illuminance at a Distance

Distance		Center Beam fc	Beam Width			
3.0ft	0.91m	265fc	0.4ft	0.12m	0.4ft	0.12m
6.0ft	1.83m	66.3fc	0.8ft	0.24m	0.8ft	0.24m
9.0ft	2.74m	29.5fc	1.2ft	0.36m	1.1ft	0.33m
12.0ft	3.66m	16.6fc	1.6ft	0.48m	1.5ft	0.45m
15.0ft	4.57m	10.6fc	2.0ft	0.61m	1.9ft	0.58m
18.0ft	5.49m	7.36fc	2.4ft	0.73m	2.3ft	0.70m

Delivered Lumen: 81 lm
 ■ Vertical Beam Spread: 7.6°
 ■ Horizontal Beam Spread: 7.2°

Polar Candela Distribution

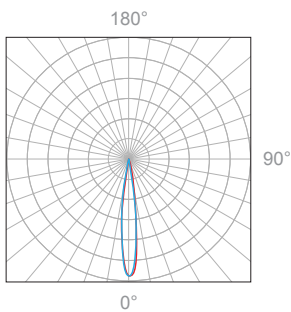

Beam Width: 12°



Illuminance at a Distance

Distance		Center Beam fc	Beam Width			
3.0ft	0.91m	180.3fc	1.0ft	0.30m	1.0ft	0.30m
6.0ft	1.83m	30.9fc	2.1ft	0.64m	2.1ft	0.64m
9.0ft	2.74m	19.2fc	3.1ft	0.94m	3.1ft	0.94m
12.0ft	3.66m	10.7fc	4.1ft	1.25m	4.1ft	1.25m
15.0ft	4.57m	7.3fc	5.2ft	1.58m	5.2ft	1.58m
18.0ft	5.49m	5fc	6.2ft	1.89m	6.2ft	1.89m

Delivered Lumen: 261 lm
 ■ Vertical Beam Spread: 19.5°
 ■ Horizontal Beam Spread: 19.5°

Polar Candela Distribution

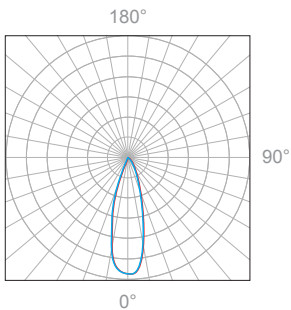

Beam Width: 30°



Illuminance at a Distance

Distance		Center Beam fc	Beam Width			
3.0ft	0.91m	114.2fc	1.4ft	0.43m	1.4ft	0.43m
6.0ft	1.83m	28.8fc	2.9ft	0.88m	2.9ft	0.88m
9.0ft	2.74m	12.8fc	4.3ft	1.31m	4.3ft	1.31m
12.0ft	3.66m	7.5fc	5.7ft	1.74m	5.7ft	1.74m
15.0ft	4.57m	4.8fc	7.2ft	2.19m	7.2ft	2.19m
18.0ft	5.49m	3.4fc	8.6ft	2.62m	8.6ft	2.62m

Delivered Lumen: 251 lm
 ■ Vertical Beam Spread: 26.9°
 ■ Horizontal Beam Spread: 26.9°

Polar Candela Distribution

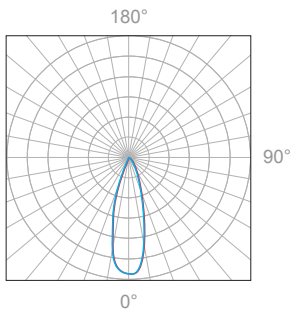

Beam Width: 48°

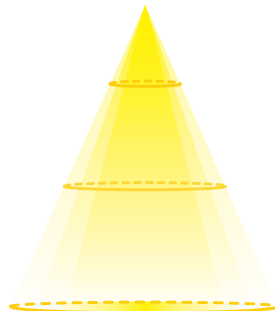

Illuminance at a Distance

Distance		Center Beam fc	Beam Width			
3.0ft	0.91m	45.9fc	2.6ft	0.79m	2.6ft	0.79m
6.0ft	1.83m	11.7fc	5.3ft	1.62m	5.3ft	1.62m
9.0ft	2.74m	5.2fc	7.9ft	2.41m	7.9ft	2.41m
12.0ft	3.66m	3fc	10.6ft	3.23m	10.6ft	3.23m
15.0ft	4.57m	2fc	13.2ft	4.02m	13.2ft	4.02m
18.0ft	5.49m	1.6fc	15.9ft	4.85m	15.9ft	4.85m

Delivered Lumen: 224 lm
 ■ Vertical Beam Spread: 47.6°
 ■ Horizontal Beam Spread: 47.6°

8W, 3000K, 90+ CRI

Polar Candela Distribution

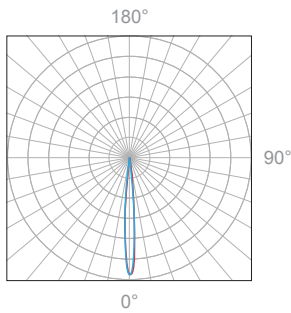

Beam Width: 7°



Illuminance at a Distance

Distance		Center Beam fc	Beam Width			
3.0ft	0.91m	463fc	0.4ft	0.12m	0.4ft	0.12m
6.0ft	1.83m	116fc	0.8ft	0.24m	0.7ft	0.21m
9.0ft	2.74m	51.5fc	1.2ft	0.36m	1.1ft	0.33m
12.0ft	3.66m	29.0fc	1.6ft	0.48m	1.5ft	0.45m
15.0ft	4.57m	18.5fc	2.0ft	0.61m	1.9ft	0.58m
18.0ft	5.49m	12.9fc	2.4ft	0.73m	2.2ft	0.67m

Delivered Lumen: 141.4 lm
 ■ Vertical Beam Spread: 7.7°
 ■ Horizontal Beam Spread: 7.1°

Polar Candela Distribution

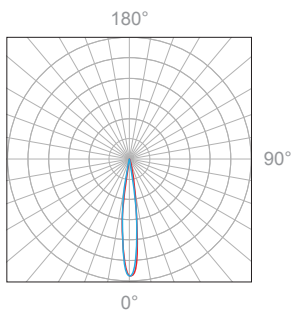

Beam Width: 12°



Illuminance at a Distance

Distance		Center Beam fc	Beam Width			
3.0ft	0.91m	328.6fc	1.0ft	0.30m	1.0ft	0.30m
6.0ft	1.83m	79fc	2.1ft	0.64m	2.1ft	0.64m
9.0ft	2.74m	35.2fc	3.1ft	0.94m	3.1ft	0.94m
12.0ft	3.66m	19.2fc	4.1ft	1.25m	4.1ft	1.25m
15.0ft	4.57m	12.8fc	5.2ft	1.58m	5.2ft	1.58m
18.0ft	5.49m	9.1fc	6.2ft	1.89m	6.2ft	1.89m

Delivered Lumen: 433 lm
 ■ Vertical Beam Spread: 19.5°
 ■ Horizontal Beam Spread: 19.5°

Polar Candela Distribution

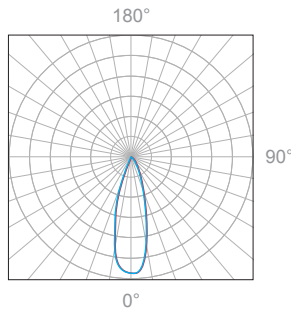

Beam Width: 30°

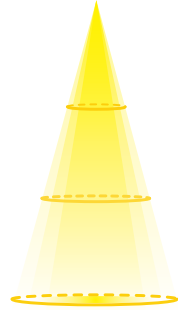

Illuminance at a Distance

Distance		Center Beam fc	Beam Width			
3.0ft	0.91m	202.7fc	1.4ft	0.43m	1.4ft	0.43m
6.0ft	1.83m	50.1fc	2.9ft	0.88m	2.9ft	0.88m
9.0ft	2.74m	21.3fc	4.3ft	1.31m	4.3ft	1.31m
12.0ft	3.66m	11.7fc	5.7ft	1.74m	5.7ft	1.74m
15.0ft	4.57m	8.2fc	7.2ft	2.19m	7.2ft	2.19m
18.0ft	5.49m	6.3fc	8.6ft	2.62m	8.6ft	2.62m

Delivered Lumen: 418 lm
 ■ Vertical Beam Spread: 26.9°
 ■ Horizontal Beam Spread: 26.9°

Polar Candela Distribution

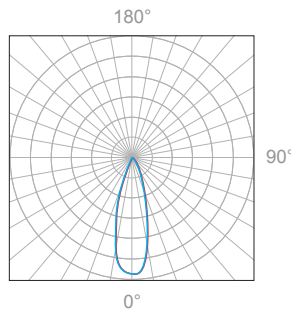

Beam Width: 48°

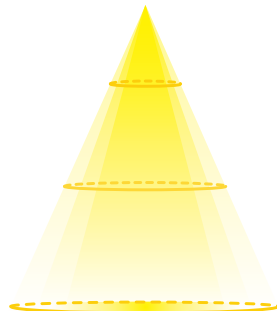

Illuminance at a Distance

Distance		Center Beam fc	Beam Width			
3.0ft	0.91m	75.7fc	2.6ft	0.79m	2.6ft	0.79m
6.0ft	1.83m	19.2fc	5.3ft	1.62m	5.3ft	1.62m
9.0ft	2.74m	8.5fc	7.9ft	2.41m	7.9ft	2.41m
12.0ft	3.66m	4.9fc	10.6ft	3.23m	10.6ft	3.23m
15.0ft	4.57m	3.3fc	13.2ft	4.02m	13.2ft	4.02m
18.0ft	5.49m	2.3fc	15.9ft	4.85m	15.9ft	4.85m

Delivered Lumen: 372 lm
 ■ Vertical Beam Spread: 47.6°
 ■ Horizontal Beam Spread: 47.6°