

L342

EXTERIOR | INTERIOR

In-grade | For decks, ceilings, walls, and stairs

- Wet, Damp, and Dry Location



Ordering Information

Clear Form

Date : _____

Quantity : _____

Project : _____

Note : _____

Type : _____

Specifications

Luminaire | Example Code: L342-2-W30H-N-C-[]-0-S6

Product	Wattage	CCT & CRI ¹	Beam Angle ²	Lens	Accessories ³ (optional)	Internal Angle Bracket ⁴	Trim Finish
L342							S6
	1 1W 2 2W	W22S 2200K 80+ W27H 2700K 90+ W30H 3000K 90+ W35H 3500K 90+ W41H 4100K 90+	S spot 12° N narrow flood 30° F flood 45° W wide flood 120°	C clear F frosted	LM louver, matte anodized LB louver, black anodized HM hex louver, matte anodized HB hex louver, black anodized AB angled louver, black anodized SB straight louver, black anodized QB square louver, black anodized RB ring louver, black anodized	0 no angle 15 15° angle X custom	Stainless Steel Finish: S6 stainless steel 316

System Components (Ordered Separately)

Remote Driver : _____

* Consult MP Lighting Website or Factory.

Important Notes

Specification

- Refer to pg.02 - Electrical for Light Quality & Colour Consistency details.
- See Light Distribution section for illustration of different combinations of beam angles and angle bracket.
- Louvers will be below the lens. Only available when there is no Internal Angle Bracket.
- Internal angle bracket is factory set, and cannot be field adjusted. 5° increments to maximum of 20° without accessories.

Warranty Notes & Disclaimer

Malfunction and damage to product due to incompatible dimming system or misuse will not be covered under warranty. Consult MP Lighting for recommended drivers. If the fixture has an option to be installed with a dimming control system, consult a dimming system manufacturer with minimum load before installing. MP Lighting reserves the right, at its sole discretion, at any time and without notice, to make design changes to any of our products. Consult MP Lighting website for most updated documentation.

L342

EXTERIOR | INTERIOR

In-grade | For decks, ceilings, walls, and stairs

- Wet, Damp, and Dry location

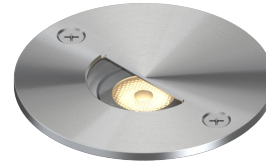

Performance

Wattage	Forward Current	Power Consumption Budget per fixture (including driver)	LED output (Source)	Fixture Output (Delivered)
1W	350mA	1.3W	110 lm	29~33 lm
2W	700mA	2.6W	220 lm	47~53 lm

Application

Environment	Wet / Damp / Dry Location approved. IP 68.
Drive Over Rating	9,700 lbs (4,400 kg)
Mounting	Recessed: Designed to be inserted into the surface and secured with two screws (included).

Electrical

Power Supplies	Remote LED drivers (120-277V AC input, constant current output): Fixtures to be wired in series.
Control	On/off control Dimming: ELV or 0-10V dimming with appropriate drivers Other options (consult factory): TRIAC/MLV, DMX, DALI, Casambi, Power over Ethernet

Luminaire Construction

LED Light Source	W22S = CCT: 2200K, CRI (Ra): 80+, Colour Consistency: 3SDCM W27H = CCT: 2700K, CRI (Ra): 90+, Colour Consistency: 2SDCM W30H = CCT: 3000K, CRI (Ra): 90+, Colour Consistency: 2SDCM W35H = CCT: 3500K, CRI (Ra): 90+, Colour Consistency: 2SDCM W41H = CCT: 4100K, CRI (Ra): 90+, Colour Consistency: 3SDCM
Standard Compliance	✓ ADA-compliant ✓ WELL standard – Feature 58: Color Quality
Weight	N/A
Material	Fixture: machined stainless steel (316)
Supplied with	Standard installation housing: Comes with two pointed end self-tapping #8-32 screws. Cable: 6" (152mm) factory-installed wire lead
Warranty & LED Life	5 years limited warranty Estimated useful life of LED is 50,000 hours.

Ordered Separately

System Components	Power supplies: remote driver Please consult factory or visit Recommended Drivers for available driver options.
-------------------	---

Mounting Options & Dimensions

LED Insert Dimensions

Fixture

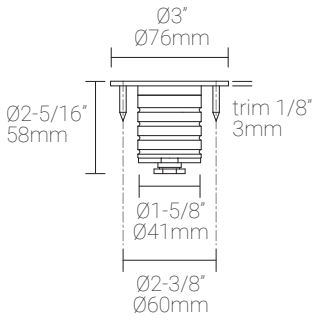

Top View



3D View



Beam



Installation with screws

Fixture with self-tapping screws:
During Installation

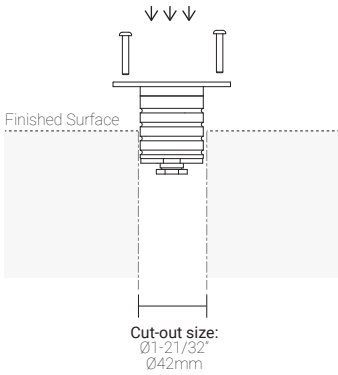

Fixture with self-tapping screws:
Complete Installation

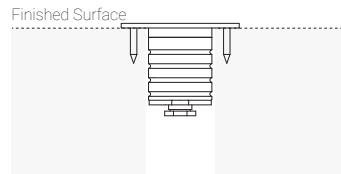

Two pointed end self-tapping
#8-32 screws provided.

Photometric Report | 1W, 3000K, 90+ CRI

Polar Candela Distribution

Beam Width: 8°

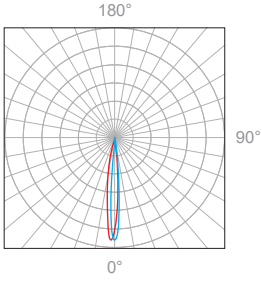

Illuminance at a Distance

Distance		Center Beam fc	Beam Width			
1.5ft	0.46m	280fc	0.2ft	0.06m	0.2ft	0.06m
3.0ft	0.91m	70fc	0.5ft	0.15m	0.4ft	0.12m
4.5ft	1.37m	31.1fc	0.7ft	0.21m	0.6ft	0.18m
6.0ft	1.83m	17.5fc	0.9ft	0.27m	0.8ft	0.24m
7.5ft	2.29m	11.2fc	1.2ft	0.36m	1.1ft	0.33m
9.0ft	2.74m	7.78fc	1.4ft	0.42m	1.3ft	0.39m

Delivered Lumen: 18 lm
 ■ Vertical Beam Spread: 8.9°
 ■ Horizontal Beam Spread: 8.0°

Polar Candela Distribution

Beam Width: 12°

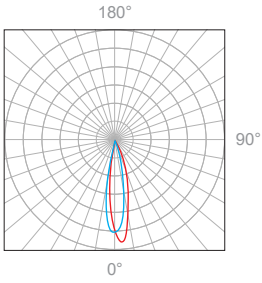

Illuminance at a Distance

Distance		Center Beam fc	Beam Width			
1.5ft	0.46m	123fc	0.6ft	0.18m	0.5ft	0.15m
3.0ft	0.91m	30fc	1.1ft	0.34m	1.0ft	0.30m
4.5ft	1.37m	13fc	1.7ft	0.52m	1.6ft	0.49m
6.0ft	1.83m	5.7fc	2.3ft	0.70m	2.1ft	0.64m
7.5ft	2.29m	4.7fc	2.9ft	0.88m	2.6ft	0.79m
9.0ft	2.74m	3.1fc	3.4ft	1.04m	3.1ft	0.95m

Delivered Lumen: 33 lm
 ■ Vertical Beam Spread: 14.0°
 ■ Horizontal Beam Spread: 14.3°

Polar Candela Distribution

Beam Width: 30°

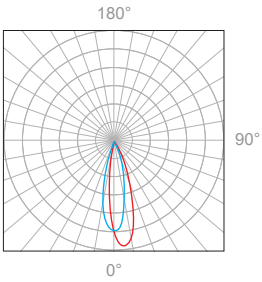

Illuminance at a Distance

Distance		Center Beam fc	Beam Width			
1.5ft	0.46m	79fc	0.8ft	0.24m	0.6ft	0.18m
3.0ft	0.91m	20fc	1.6ft	0.49m	1.3ft	0.40m
4.5ft	1.37m	8.8fc	2.4ft	0.73m	1.9ft	0.58m
6.0ft	1.83m	5fc	3.2ft	0.98m	2.6ft	0.79m
7.5ft	2.29m	3.1fc	4.0ft	1.22m	3.2ft	0.98m
9.0ft	2.74m	1.9fc	4.8ft	1.46m	3.8ft	1.16m

Delivered Lumen: 33 lm
 ■ Vertical Beam Spread: 29.9°
 ■ Horizontal Beam Spread: 24.1°

Polar Candela Distribution

Beam Width: 45°

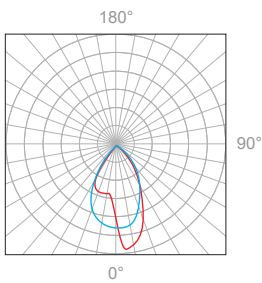

Illuminance at a Distance

Distance		Center Beam fc	Beam Width			
3.0ft	0.91m	6.07fc	2.3ft	0.70m	1.5ft	0.45m
6.0ft	1.83m	1.52fc	4.7ft	1.43m	3.0ft	0.91m
9.0ft	2.74m	0.67fc	7.0ft	2.13m	4.5ft	1.37m
12.0ft	3.65m	0.38fc	9.3ft	2.83m	5.9ft	1.79m
15.0ft	4.57m	0.24fc	11.7ft	3.56m	7.4ft	2.25m
18.0ft	5.48m	0.17fc	14.0ft	4.26m	8.9ft	2.71m

Delivered Lumen: 41 lm
 ■ Vertical Beam Spread: 42.5°
 ■ Horizontal Beam Spread: 27.8°

Polar Candela Distribution

Beam Width: 120°

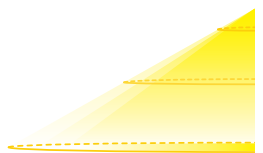
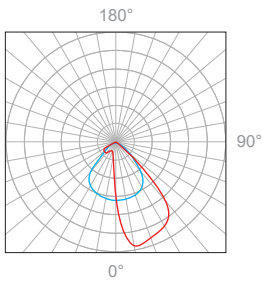

Illuminance at a Distance

Distance		Center Beam fc	Beam Width			
1.5ft	0.46m	6.6fc	2.7ft	0.82m	1.2ft	0.37m
3.0ft	0.91m	2.7fc	5.4ft	1.65m	2.5ft	0.76m
4.5ft	1.37m	1.3fc	8.0ft	2.40m	3.7ft	1.13m
6.0ft	1.83m	0.73fc	10.7ft	3.26m	4.9ft	1.49m
7.5ft	2.29m	0.47fc	13.4ft	4.08m	6.1ft	1.86m
9.0ft	2.74m	0.32fc	16.1ft	4.91m	7.4ft	2.26m

Delivered Lumen: 29 lm
 ■ Vertical Beam Spread : 83.6°
 ■ Horizontal Beam Spread : 44.4°

Photometric Report | 2W, 3000K, 90+ CRI

Polar Candela Distribution

Beam Width: 8°

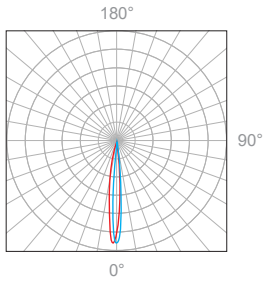

Illuminance at a Distance

Distance		Center Beam fc	Beam Width			
1.5ft	0.46m	479fc	0.2ft	0.06m	0.2ft	0.06m
3.0ft	0.91m	120fc	0.5ft	0.15m	0.4ft	0.12m
4.5ft	1.37m	53.3fc	0.7ft	0.21m	0.7ft	0.21m
6.0ft	1.83m	30.0fc	0.9ft	0.27m	0.9ft	0.27m
7.5ft	2.29m	19.2fc	1.1ft	0.33m	1.1ft	0.33m
9.0ft	2.74m	13.3fc	1.4ft	0.42m	1.3ft	0.39m

Delivered Lumen: 31.9 lm
 ■ Vertical Beam Spread: 8.7°
 ■ Horizontal Beam Spread: 8.3°

Polar Candela Distribution

Beam Width: 12°

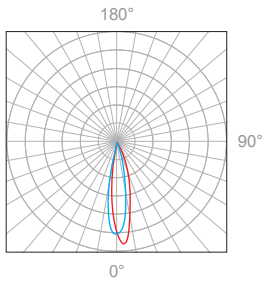

Illuminance at a Distance

Distance		Center Beam fc	Beam Width			
1.5ft	0.46m	285fc	0.6ft	0.18m	0.5ft	0.15m
3.0ft	0.91m	91fc	1.1ft	0.34m	1.0ft	0.30m
4.5ft	1.37m	32fc	1.7ft	0.52m	1.6ft	0.49m
6.0ft	1.83m	17fc	2.3ft	0.70m	2.1ft	0.64m
7.5ft	2.29m	11fc	2.9ft	0.88m	2.6ft	0.79m
9.0ft	2.74m	7.2fc	3.4ft	1.04m	3.1ft	0.95m

Delivered Lumen: 53 lm
 ■ Vertical Beam Spread: 14.0°
 ■ Horizontal Beam Spread: 14.3°

Polar Candela Distribution

Beam Width: 30°

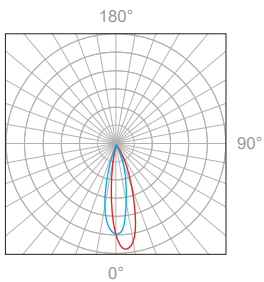

Illuminance at a Distance

Distance		Center Beam fc	Beam Width			
1.5ft	0.46m	171fc	0.8ft	0.24m	0.6ft	0.18m
3.0ft	0.91m	41fc	1.6ft	0.49m	1.3ft	0.40m
4.5ft	1.37m	18fc	2.4ft	0.73m	1.9ft	0.58m
6.0ft	1.83m	9.4fc	3.2ft	0.98m	2.6ft	0.79m
7.5ft	2.29m	6fc	4.0ft	1.22m	3.2ft	0.98m
9.0ft	2.74m	4.2fc	4.8ft	1.46m	3.8ft	1.16m

Delivered Lumen: 52 lm
 ■ Vertical Beam Spread: 29.9°
 ■ Horizontal Beam Spread: 24.1°

Polar Candela Distribution

Beam Width: 45°

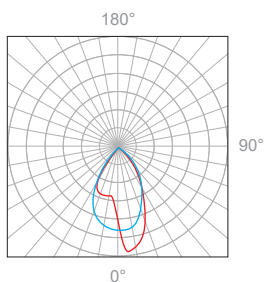

Illuminance at a Distance

Distance		Center Beam fc	Beam Width			
3.0ft	0.91m	1.11fc	2.3ft	0.70m	1.5ft	0.45m
6.0ft	1.83m	2.77fc	4.7ft	1.43m	3.0ft	0.91m
9.0ft	2.74m	1.23fc	7.1ft	2.16m	4.5ft	1.37m
12.0ft	3.65m	0.69fc	9.5ft	2.89m	6.0ft	1.82m
15.0ft	4.57m	0.44fc	11.8ft	3.59m	7.5ft	2.28m
18.0ft	5.48m	0.31fc	14.2ft	4.32m	9.0ft	2.74m

Delivered Lumen: 73.6 lm
 ■ Vertical Beam Spread: 43°
 ■ Horizontal Beam Spread: 28.2°

Polar Candela Distribution

Beam Width: 120°

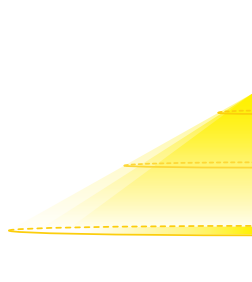
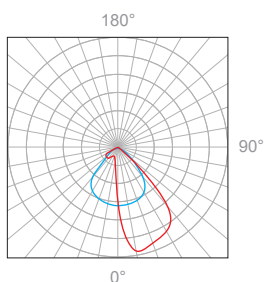

Illuminance at a Distance

Distance		Center Beam fc	Beam Width			
1.5ft	0.46m	11fc	2.7ft	0.82m	1.2ft	0.37m
3.0ft	0.91m	4.9fc	5.4ft	1.65m	2.5ft	0.76m
4.5ft	1.37m	2.4fc	8.0ft	2.40m	3.7ft	1.13m
6.0ft	1.83m	1.4fc	10.7ft	3.26m	4.9ft	1.49m
7.5ft	2.29m	0.93fc	13.4ft	4.08m	6.1ft	1.86m
9.0ft	2.74m	0.64fc	16.1ft	4.91m	7.4ft	2.26m

Delivered Lumen: 47 lm
 ■ Vertical Beam Spread : 83.6°
 ■ Horizontal Beam Spread : 44.4°