

L372

LED In-grade

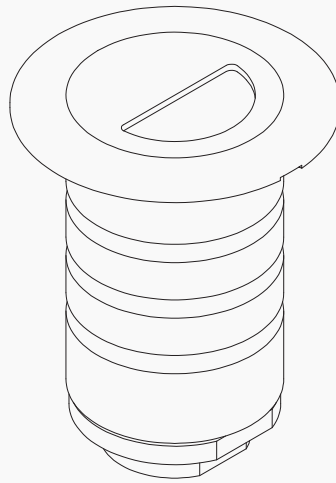

Standard Flange

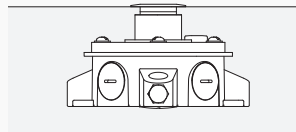

Wall Mount

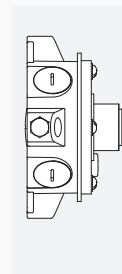

L372

LED In-grade

Parts

L372 Back Box

LED trim x 1

Waterproof wire nut x 2

Lubrication grease — Included

Remove flange, install wiring and conduit. Refer to applicable wiring diagram.

Replace flange. Ensure all gaskets are in place and knockouts are plugged.

DO NOT LET CONCRETE ENTER BOX.

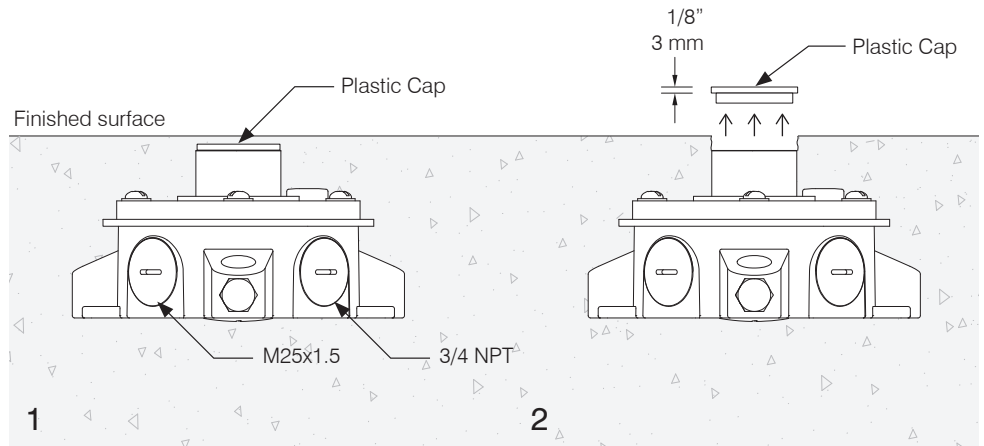

1) Position electrical box.
Recommended distance is 1/4" (6mm) maximum from top of poured concrete to the flange. Use mounting tabs or optional mounting hardware to level box.

2) After concrete has cured, crack concrete above flange and remove plastic cap using a corkscrew or similar tool.

3) The power to the remote driver must be off while wiring LED fixtures to drivers. Connect fixture leads to box wiring using supplied waterproof wire nuts.

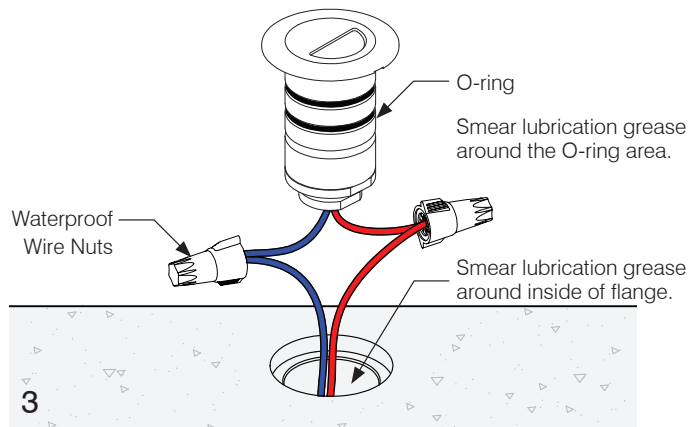

4) APPLY GREASE (lubrication grease) to bottom of trim on o-rings and inside of flange, for proper insertion and removal of trim. Inside of flange must be clean before applying lubrication grease.

5) With a twisting back and forth motion insert trim into flange.

6) If fixture has an angle bracket, make sure beam is lined up in desired direction when inserting the trim.

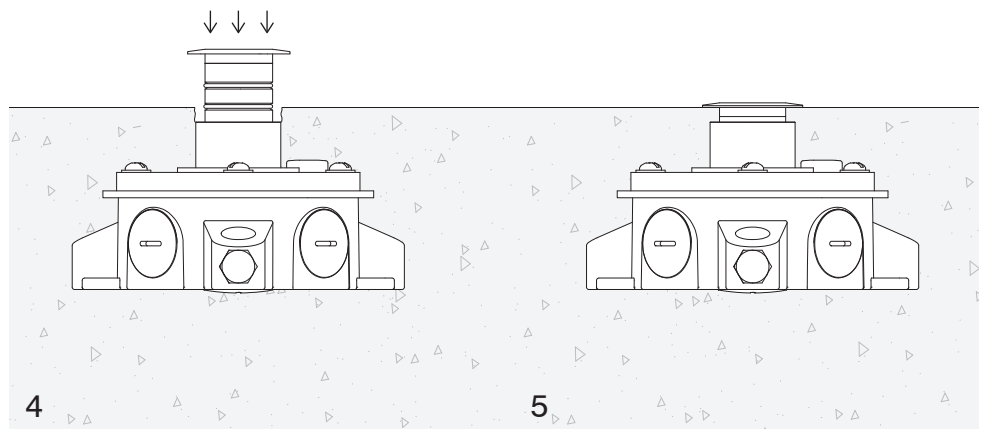

IMPORTANT SAFETY INSTRUCTIONS

KEEP THESE INSTALLATION INSTRUCTIONS

(Including General and Additional Markings for Fixtures)

(FOR MP LIGHTING LED LUMINAIRES, CLASS 3402-xx)

General and additional markings

1. For Use Only with Certified/NRTL Driver, Model _____
2. DRY LOCATIONS ONLY or OUTDOOR USE ONLY or DRY/
OUTDOOR USE ONLY or Outdoor / submersible Use Only - as
indicated on fixtures
3. MIN 90 C SUPPLY CONDUCTORS
4. Model L92: SUITABLE FOR MOUNTING WITHIN 1.2 M (4FT) OF
THE GROUND
5. Models L01, L03, L04, L05, L06, L07, L300, L301, L302, L303,
L304, L305, L306, L307, L320, L321, L324, L325, L326, L352,
L370 and L371: SUITABLE FOR USE IN POURED CONCRETE,
USE ON CLASS 2 CIRCUIT ONLY
6. Models with Class 2 LED Drivers which are intended for
installation for other than Indoor Use Only: CAUTION:
CONNECTED ONLY TO A CIRCUIT PROTECTED BY A CLASS A
GROUND FAULT CIRCUIT INTERRUPTER

Installation instructions

1. The grounding installation shall be done in accordance with
CEC-Part 1.
2. WARNING: RISK OF FIRE OR ELECTRIC SHOCK: DO NOT
MAKE OR ALTER ANY OPENINGS IN THE COMPARTMENT
OF WIRING OR ELECTRICAL COMPONENTS DURING
INSTALLATION. DO NOT ALTER OR ADD BALLASTS, OR ANY
OTHER ELECTRICAL COMPONENTS.
3. INSTALLATION AND USE OF THIS FIXTURE MOUNTING
ASSEMBLY REQUIRES A PERSON FAMILIAR WITH THE
CONSTRUCTION AND OPERATION OF LUMINAIRE
ELECTRICAL SYSTEMS AND THE HAZARD INVOLVED, IF NOT
QUALIFIED, DO NOT ATTEMPT INSTALLATION. CONTACT A
QUALIFIED ELECTRICIAN.
4. TURN OFF POWER BEFORE INSTALLATION.
5. KEEP THESE INSTALLATION INSTRUCTIONS.

CONSIGNES DE SÉCURITÉ IMPORTANTES

CONSERVER CES INSTRUCTIONS D'INSTALLATION

(Dont le général et marques supplémentaires pour les appareils)

(Pour les luminaires LED MP D'ÉCLAIRAGE , CLASS 3402 -xx)

Général et marquages supplémentaires

1. A utiliser uniquement avec Certified / NRTL pilote, modèle _____
2. POUR EMPLACEMENTS SECS SEULEMENT ou UTILISATION
EXTÉRIEURE SEULEMENT ou SEC / UTILISATION EXTÉRIEURE
SEULEMENT ou extérieure / Utilisation submersible seulement -
comme indiqué sur les appareils
3. LES FILS D'ALIMENTATION 90 °C MIN
4. Modèle L92: Pour montage moins de 1,2 m (4 pi) DE LA TERRE
5. Modèles L01, L03, L04, L05, L06, L07 L300, L301, L302, L303,
L304, L305, L306, L307, L320, L321, L324, L325, L326, L352,
L370 et L371: utilisables dans le béton coulé, UTILISATION DE
CLASSE 2 CIRCUIT UNIQUEMENT
6. ATTENTION: CONNECTED UNIQUEMENT À UN CIRCUIT
PROTÉGÉ PAR UN DISJONCTEUR DIFFÉRENTIEL DE CLASS A

Les instructions d'installation

1. L'installation de mise à la terre doit être fait en conformité avec
CEC Partie 1.
2. AVERTISSEMENT : RISQUE D'INCENDIE OU
D'ÉLECTROCUTION : NE PAS FAIRE OU MODIFIER DES
OUVERTURES DANS LE COMPARTIMENT DE CÂBLAGE OU
DE COMPOSANTS ÉLECTRIQUES LORS DE L'INSTALLATION.
NE PAS MODIFIER OU AJOUTER DES BALLASTS, OU AUTRES
COMPOSANTS ÉLECTRIQUES
3. CE PRODUIT DOIT ÊTRE INSTALLÉ SELON LE CODE
D'INSTALLATION PERTINENT, PAR UNE PERSONNE QUI
CONNAÎT BIEN LE PRODUIT ET SON FONCTIONNEMENT
AINSI QUE LES RISQUES INHÉRENTS. CONSULTER UN
ÉLECTRICIEN QUALIFIÉ.
4. COUPER LE COURANT AVANT L'INSTALLATION.
5. CONSERVEZ CES INSTRUCTIONS.