

L403

EXTERIOR | INTERIOR
Recessed Downlight

○ Damp and Dry location



Ordering Information

Clear Form

Date :	_____	Quantity :	_____
Project :	_____	Note :	_____
Type :	_____		_____

Specifications

Luminaire | Example Code: L403-26-L-WD-S-B-BK

Product	Wattage ¹	Dimming	CCT & CRI ³	Beam Angle	Reflector Colour ⁴	Trim Finish
L403	26					
	26 26W	Integral Driver: D 0~10V dimming T Triac dimming LU Lutron dimming Remote Driver: M DMX L DALI Non-dimmable: ² ND non-dimmable	Standard LED Module: W27H 2700K 90+ W30H 3000K 90+ W35H 3500K 90+ W27V 2700K 97+ W30V 3000K 97+ Custom LED Module: Warm Dim: WD 1800K-3000K 95+ Xicato Artist: X27 2700K 95+ X30 3000K 95+ X35 3500K 95+ Lumenetix: L 1650K-4000K 90+	S spot 15° N narrow flood 30° F flood 40°	S silver specular B black specular	WH white powder coat BK black powder coat

System Components (Ordered Separately)

Remote Driver : _____

* Consult MP Lighting Website or Factory.

Important Notes

Specifications

- 17W for Lumenetix & Xicato Artist.
- Non-dimmable option: 120V input only.
- For custom LED module option, lead time might vary. Please consult factory to specify this option and confirm the specific lead time.
- WD (Warm Dimming) will not have a reflector.

Further information and images

For custom LED module option, lead time might vary. Please consult factory to specify this option and confirm the specific lead time. For images of different colour options, please refer to **Appendix**.

Warranty Notes & Disclaimer

Malfunction and damage to product due to incompatible dimming system or misuse will not be covered under warranty. Consult MP Lighting for recommended drivers. Only DC Drivers are recommended for dimming systems. If the fixture has an option to be installed with a dimming control system, consult a dimming system manufacturer with minimum load before installing. MP Lighting reserves the right, at its sole discretion, at any time without notice, to make design changes to any of our products.

L403

EXTERIOR | INTERIOR
Recessed Downlight

○ Damp and Dry location



Performance

LED Module	Wattage	Forward Current	Power Consumption Budget per fixture (including driver)	LED output (Source)	Fixture Output (Delivered)
Standard	26W	700mA	31W	2860 lm	1190-1580 lm
Xicato Artist	17W	500mA	21W	1870 lm	645-689.5 lm
Lumenetix	26W	700mA	31W	2860 lm	1190-1271.5 lm
Warm Dim	26W	700mA	31W	2860 lm	887-948 lm

Application

Environment	Dry / Damp Location approved. IP 54.
Field Customization	Field replaceable LED Zhaga module
Mounting	Non-insulated type frame in kit with hanger bars to mount to joist. Ceiling cutout size: Ø4"(102mm)

Electrical

Electrical	<p>Integral Driver: 120V AC (Triac, 0-10V, or Lutron), 277V AC (0-10V)</p> <p>Remote Driver: 120V AC or 277V AC (DMX or DALI)</p> <p>Remote Emergency Driver/inverter options available, please consult factory for more information.</p>
------------	---

Luminaire Construction

Weight	1.2 lbs (548 g).
Material	Fixture: aluminum
Supplied with	Non-insulated housing
Warranty & LED Life	5 years limited warranty Estimated useful life of LED is 50,000 hours.

Ordered Separately

System Components	Power supplies: remote driver
-------------------	--------------------------------------

Mounting Options & Dimensions

LED Insert Dimensions

Fixture

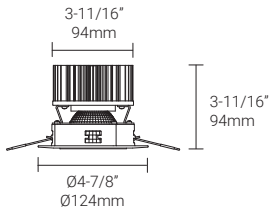

Front View

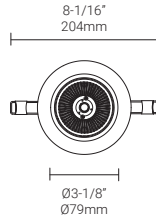

3D View



Beam

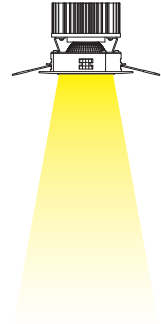

Non-Insulated Housing

Side View

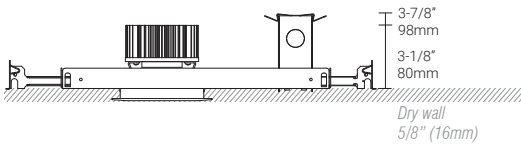

Front View

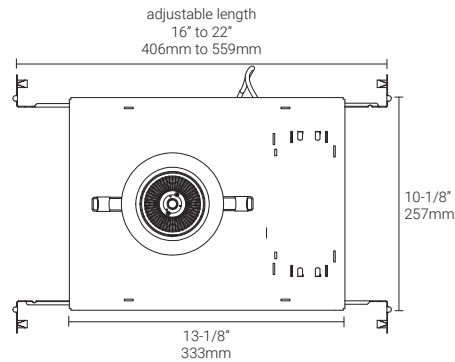

3D View



Standard LED Module | 26W, 3000K, 90+ CRI | Silver Reflector

Polar Candela Distribution

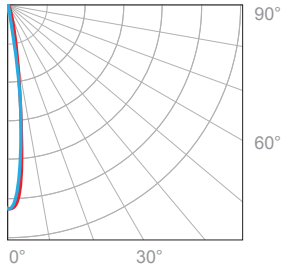

Beam Width: 15°



Illuminance at a Distance

Distance		Center Beam fc	Beam Width			
3.0ft	0.91m	1298fc	0.8ft	0.24m	0.8ft	0.24m
6.0ft	1.83m	324.6fc	1.6ft	0.48m	1.6ft	0.48m
9.0ft	2.74m	144.3fc	2.4ft	0.73m	2.4ft	0.73m
12ft	3.66m	81.1fc	3.2ft	0.97m	3.2ft	0.97m
15ft	4.57m	51.9fc	3.9ft	1.19m	4.0ft	1.22m
18ft	5.49m	36.1fc	4.7ft	1.43m	4.8ft	1.46m

Delivered Lumen: 1580 lm
 ■ Vertical Beam Spread: 15.0°
 ■ Horizontal Beam Spread: 15.2°

Polar Candela Distribution

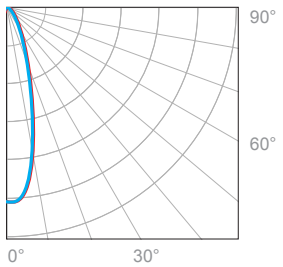

Beam Width: 30°



Illuminance at a Distance

Distance		Center Beam fc	Beam Width			
3.0ft	0.91m	316.3fc	1.6ft	0.48m	1.6ft	0.48m
6.0ft	1.83m	79.1fc	3.3ft	1.00m	3.3ft	1.00m
9.0ft	2.74m	35.1fc	4.9ft	1.49m	4.9ft	1.49m
12ft	3.66m	19.8fc	6.5ft	1.98m	6.5ft	1.98m
15ft	4.57m	12.7fc	8.2ft	2.49m	8.2ft	2.49m
18ft	5.49m	8.8fc	9.9ft	3.01m	9.9ft	3.01m

Delivered Lumen: 1190 lm
 ■ Vertical Beam Spread: 30.7°
 ■ Horizontal Beam Spread: 30.7°

Polar Candela Distribution

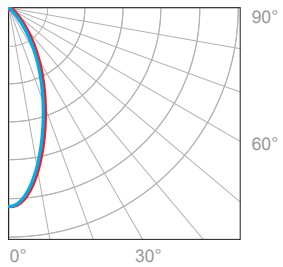

Beam Width: 40°

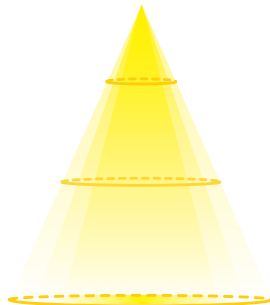

Illuminance at a Distance

Distance		Center Beam fc	Beam Width			
3.0ft	0.91m	243.2fc	2.2ft	0.67m	2.2ft	0.67m
6.0ft	1.83m	60.8fc	4.4ft	1.34m	4.3ft	1.31m
9.0ft	2.74m	27.0fc	6.6ft	2.01m	6.5ft	1.98m
12ft	3.66m	15.2fc	8.8ft	2.68m	8.7ft	2.65m
15ft	4.57m	9.7fc	11.0ft	3.35m	10.9ft	3.32m
18ft	5.49m	6.8fc	13.1ft	3.99m	13.0ft	3.96m

Delivered Lumen: 1271.5 lm
 ■ Vertical Beam Spread : 40.1°
 ■ Horizontal Beam Spread : 39.8°

Appendix

Aluminum Finishes

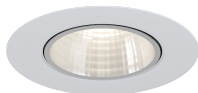

WH white trim with silver reflector

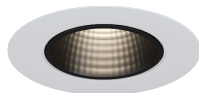

WH white trim with black reflector



BK black trim with silver reflector

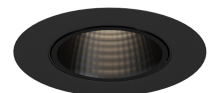

BK black trim with black reflector

Halogen Dim (Warm Dim)

Warm Dim VS. Halogen

