

L423

INTERIOR

Recessed Downlight | For ceilings, soffits

○ Damp and Dry location



Ordering Information

Clear Form

Date :	_____	Quantity :	_____
Project :	_____	Note :	_____
Type :	_____		_____

Specifications

Luminaire | Example Code: L423-NI-M-13-W30H-55-ELB-WH

Product	Mounting	Dimming	Version	CCT & CRI	Beam Angle	Accessories ² (optional)	Trim Finish ³
L423			13				WH
	NI non-insulated R retrofit driver	M MLV dimming (120V) D 0-10V dimming (120-277V)	13 13W	W27H 2700K 90+ CRI W30H 3000K 90+ CRI W35H 3500K 90+ CRI W27V 2700K 97+ CRI W30V 3000K 97+ CRI WD warm dimming (1800-3000K, 95+ CRI) ¹	15 15° 20 20° 26 26° 45 45°	ELB eggcrate louver, black	WH white powder coat

System Components (Ordered Separately)

Remote Driver : _____

* Consult MP Lighting Website or Factory.

Important Notes

Specification

1. Refer to pg.4 or [Warm Dimming](#) for details.
2. Refer to Appendix for louver's image.
3. Consult factory to specify RAL #. RAL match requires longer lead time.

Warranty Notes & Disclaimer

Malfunction and damage to product due to incompatible dimming system or misuse will not be covered under warranty. Consult MP Lighting for recommended drivers. If the fixture has an option to be installed with a dimming control system, consult a dimming system manufacturer with minimum load before installing. MP Lighting reserves the right, at its sole discretion, at any time and without notice, to make design changes to any of our products. Consult MP Lighting website for most updated documentation.

L423

INTERIOR

Recessed Downlight | For ceilings, soffits

○ Damp and Dry location



Performance

Wattage	Forward Current	Power Consumption Budget per fixture (including driver)	LED output (Source)	Fixture Output (Delivered)
13W	350mA	13W	1430 lm	892-1200 lm

Application

Environment	Damp and Dry Location approved. IP 54.
Mounting	Mounts with spring clips. Cut-out size: Ø 2-3/4" (69.85mm) Cord Length: 22-1/4" (565mm)

Electrical

Power Supplies	Comes with: Remote LED drivers (120V AC input, MLV dimmable) OR Remote LED drivers (120-277V AC input, 0-10V dimmable)
Control	On/off control Dimming: MLV/ 0-10V dimming with appropriate drivers Other options (consult factory): TRIAC/MLV, DMX, DALI, Casambi, Power over Ethernet

Luminaire Construction

LED Light Source	W27H = CCT: 2700K, CRI (Ra): 90+, Colour Consistency: 2SDCM W30H = CCT: 3000K, CRI (Ra): 90+, Colour Consistency: 2SDCM W35H = CCT: 3500K, CRI (Ra): 90+, Colour Consistency: 2SDCM W27V = CCT: 2700K, CRI (Ra): 97+, Colour Consistency: 2SDCM W30V = CCT: 3000K, CRI (Ra): 97+, Colour Consistency: 2SDCM WD = CCT: 1800K-3000K, CRI (Ra): 95+
Weight	With NI housing: 4.5lbs (2.04kg). With R housing: 1.8lbs (0.81kg)
Material	Fixture: machined marine-grade aluminum
Supplied with	Non-insulated housing: Comes with frame, built-in nailer, housing cover, and cord Retrofit driver: remote driver housing and cord
Warranty & LED Life	5 years limited warranty Estimated useful life of LED is 50,000 hours.

Mounting Options & Dimensions

LED Fixture Dimensions

Fixture

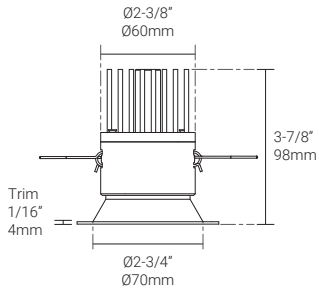

Top View

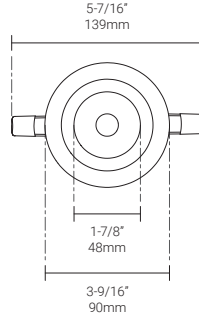

3D View



Beam

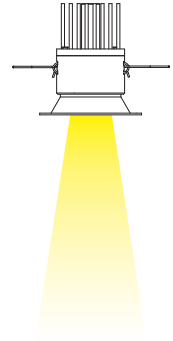

Non-insulated housing with driver

Side View

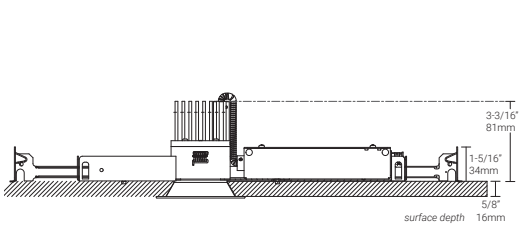

Bottom View

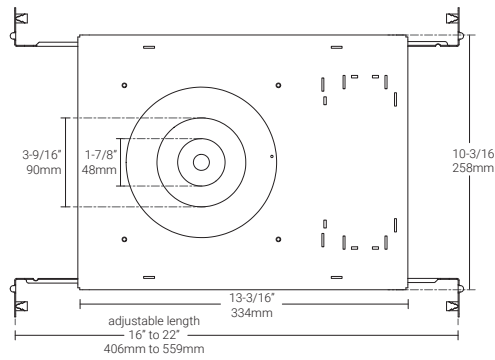

3D View



Retrofit housing with driver

Side View

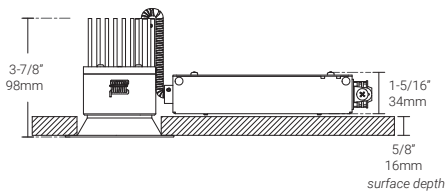

Top View

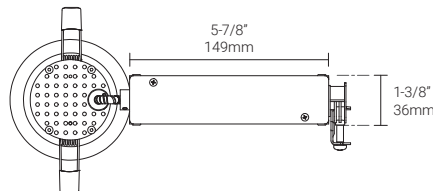

3D View



13W, 3000K, 90+ CRI

Polar Candela Distribution

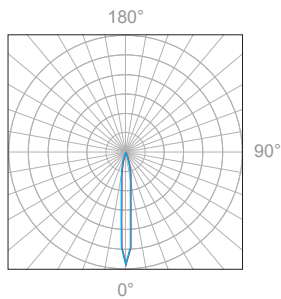

Beam Width: 15°



Illuminance at a Distance

Distance		Center Beam fc	Beam Width			
3.0ft	0.91m	835fc	0.9ft	0.27m	0.9ft	0.27m
6.0ft	1.83m	209fc	1.8ft	0.54m	1.8ft	0.54m
9.0ft	2.74m	92.8fc	2.7ft	0.82m	2.7ft	0.82m
12.0ft	3.65m	52.2fc	3.6ft	1.09m	3.6ft	1.09m
15.0ft	4.57m	33.4fc	4.5ft	1.37m	4.4ft	1.34m
18.0ft	5.48m	23.2fc	5.4ft	1.64m	5.3ft	1.61m

Delivered Lumen: 892.2 lm
 ■ Vertical Beam Spread: 17.1°
 ■ Horizontal Beam Spread: 16.8°

Polar Candela Distribution

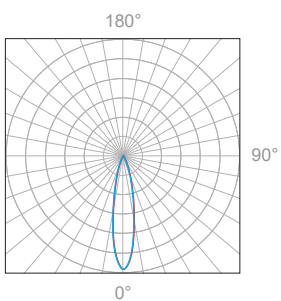

Beam Width: 20°



Illuminance at a Distance

Distance		Center Beam fc	Beam Width			
3.0ft	0.91m	873fc	1.0ft	0.30m	1.0ft	0.30m
6.0ft	1.83m	218fc	2.0ft	0.61m	2.1ft	0.64m
9.0ft	2.74m	97.0fc	3.0ft	0.91m	3.1ft	0.94m
12.0ft	3.65m	54.6fc	4.0ft	1.22m	4.2ft	1.28m
15.0ft	4.57m	34.9fc	5.0ft	1.52m	5.2ft	1.58m
18.0ft	5.48m	24.2fc	6.0ft	1.82m	6.3ft	1.92m

Delivered Lumen: 1200.8 lm
 ■ Vertical Beam Spread: 18.9°
 ■ Horizontal Beam Spread: 19.9°

Polar Candela Distribution

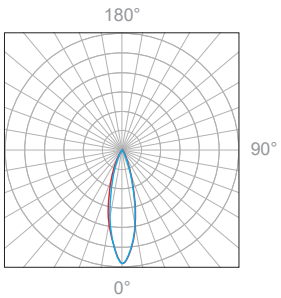

Beam Width: 26°



Illuminance at a Distance

Distance		Center Beam fc	Beam Width			
3.0ft	0.91m	492fc	1.4ft	0.42m	1.4ft	0.42m
6.0ft	1.83m	123fc	2.7ft	0.82m	2.7ft	0.82m
9.0ft	2.74m	54.7fc	4.1ft	1.25m	4.1ft	1.25m
12.0ft	3.65m	123fc	5.5ft	1.67m	5.5ft	1.67m
15.0ft	4.57m	78.7fc	6.9ft	2.10m	6.8ft	2.07m
18.0ft	5.48m	54.7fc	8.2ft	2.50m	8.2ft	2.50m

Delivered Lumen: 1155 lm
 ■ Vertical Beam Spread: 25.8°
 ■ Horizontal Beam Spread: 25.7°

Polar Candela Distribution

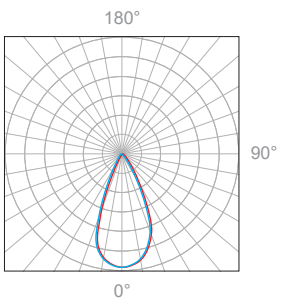

Beam Width: 45°

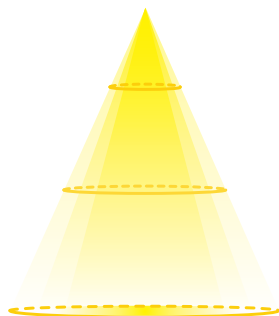

Illuminance at a Distance

Distance		Center Beam fc	Beam Width			
3.0ft	0.91m	191fc	2.5ft	0.76m	2.5ft	0.76m
6.0ft	1.83m	47.8fc	5.0ft	1.52m	5.0ft	1.52m
9.0ft	2.74m	21.2fc	7.5ft	2.28m	7.5ft	2.28m
12.0ft	3.65m	11.9fc	10.0ft	3.04m	9.9ft	3.01m
15.0ft	4.57m	7.65fc	12.5ft	3.81m	12.4ft	3.78m
18.0ft	5.48m	5.31fc	15.0ft	4.57m	14.9ft	4.54m

Delivered Lumen: 1109.6 lm
 ■ Vertical Beam Spread: 45.2°
 ■ Horizontal Beam Spread: 45.0°

Warm Dimming VS. Halogen

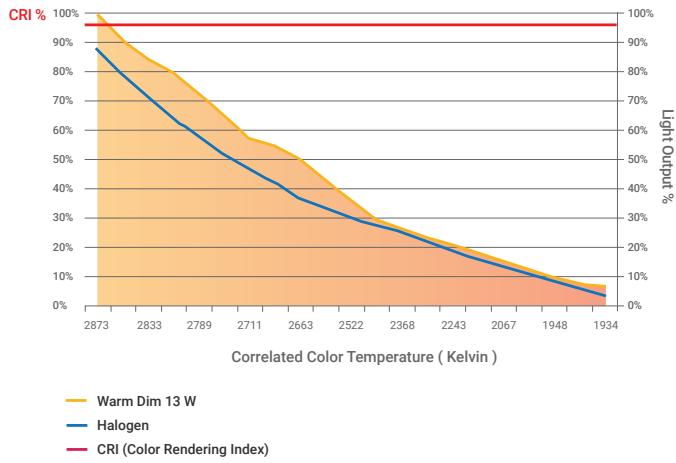

Appendix

Trim Finishes



WH white powder coat

Accessories

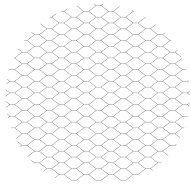

ACCS-ELB eggcrate louver, black