

L517

INTERIOR

Downlight | For open and bulkhead ceilings

● Dry location

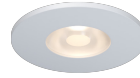

Shown with with **NA** (no accessories)



Shown with with **SH** (metal shroud, silver)
* Refer to Appendix for other shroud options.

Ordering Information

Clear Form

Date : _____

Quantity : _____

Project : _____

Note : _____

Type : _____

Specifications

Luminaire | Example Code: L517-C-3-W30H-N-NA-MA

| Product | Mounting | Version | CCT & CRI ¹ | Beam Angle | Shrouds/Accessories (optional) | Finish ² |
|---------|--------------------|---------|----------------------------------|---|---|--|
| L517 | C | 4 | | | | |
| | C coil spring clip | 4 4W | W27H 2700K 90+ W30H 3000K 90+ | S spot 12° N narrow flood 15° F flood 26° W wide flood 45° | NA no accessories SH metal shroud, silver SHB metal shroud, black | Aluminum Finishes: MA matte clear anodized BA black anodized BZ bronze powder coated WH white powder coated |

System Components (Ordered Separately)

Remote Driver : _____

* Consult MP Lighting Website or Factory.

Important Notes

Specification

1. Refer to pg.2 - for Light Quality & Colour Consistency details.
2. Refer to Appendix or MP Lighting website for complete look of luminaire with different trim finish options.

Warranty Notes & Disclaimer

Malfunction and damage to product due to incompatible dimming system or misuse will not be covered under warranty. Consult MP Lighting for recommended drivers. If the fixture has an option to be installed with a dimming control system, consult a dimming system manufacturer with minimum load before installing. MP Lighting reserves the right, at its sole discretion, at any time and without notice, to make design changes to any of our products. Consult MP Lighting website for most updated documentation.

L517

INTERIOR

Downlight | For open and bulkhead ceilings

- Dry location

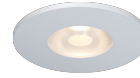

Shown with with **NA** (no accessories)



Shown with with **SH** (metal shroud, silver)
* Refer to Appendix for other shroud options.

Performance

| Wattage | Forward Current | Power Consumption Budget per fixture (including driver) | LED output (Source) | Fixture Output (Delivered) |
|---------|-----------------|---|---------------------|----------------------------|
| 4W | 350mA | 4.5W | 440 lm | 80-197 lm |

Application

| | |
|-------------|---|
| Environment | Dry Location approved. IP 40. |
| Mounting | C: Recessed mount with coil spring clip. Mounts directly to cabinet millwork or mounts to standard 4" octagonal back box (supplied by others) using MP Lighting cover plate (PLT-CS-01, ordered separately) in drywall applications. Cut-out size: Ø2-1/2" (Ø64mm) |

Electrical

| | |
|------------|--|
| Electrical | Remote LED drivers (120-277V AC input, constant current output): Fixtures to be wired in series. Remote LED drivers (120-277V AC input, constant voltage output): Fixtures to be wired in parallel. |
| Control | On/off control Dimming: ELV or 0-10V dimming with appropriate drivers Other options (consult factory): TRIAC/MLV, DMX, DALI, Casambi, Power over Ethernet |

Luminaire Construction

| | |
|---------------------|--|
| LED Light Source | W22S = CCT: 2200K, CRI (Ra): 80+, Colour Consistency: 3SDCM W27H = CCT: 2700K, CRI (Ra): 90+, Colour Consistency: 2SDCM W30H = CCT: 3000K, CRI (Ra): 90+, Colour Consistency: 2SDCM W35H = CCT: 3500K, CRI (Ra): 90+, Colour Consistency: 2SDCM W41H = CCT: 4100K, CRI (Ra): 90+, Colour Consistency: 3SDCM |
| Standard Compliance | ✓ADA-compliant ✓WELL standard – Feature 58: Color Quality |
| Weight | N/A |
| Material | Fixture: machined marine-grade aluminum |
| Supplied with | Standard installation: Comes with friction fit spring clip or coil spring clip, and 2'(610mm) wire lead. |
| Warranty & LED Life | 5 years limited warranty Estimated useful life of LED is 50,000 hours. |

Ordered Separately

| | |
|-------------------|---|
| System Components | Power supplies: remote driver Please consult factory or visit Recommended Drivers for available driver options. Mounting Plate for Coil Spring Clip (PLT-CS-01): Refer to pg.4- Mounting Plate for Installation with standard 4" octagonal back box (supplied by others) in drywall applications. |
|-------------------|---|

Mounting Options & Dimensions

LED Fixture Dimensions | with C, coil spring clip

Fixture

Top View

3D View

Beam

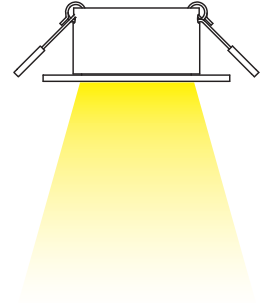
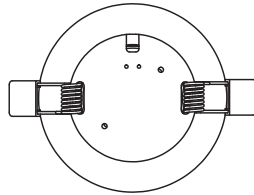
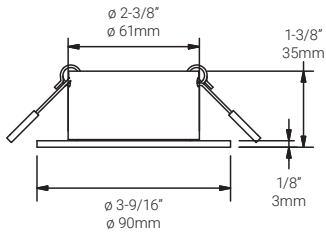

Shroud Options and Dimensions (shown with C, coil spring clip)

Cut-out size:
Ø2-1/2"
Ø64mm

Cut-out size:
Ø2-1/2"
Ø64mm

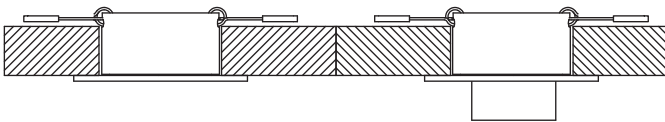

12°/30°
FS (full shroud)

Recessed mount Installation | Shown with C, coil spring clip

Fixture

Push LED housing with coil spring clip into Ø1-1/2" (Ø38mm) hole until flush with surface.

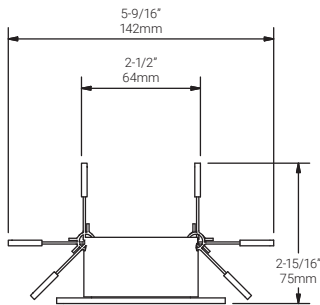

Cut-out size:
Ø2-1/2"
Ø64mm

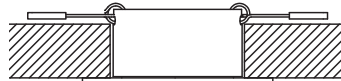

4W, 3000K, 90+ CRI, 30°

**Polar Candela Distribution
NA (No Accessories)**

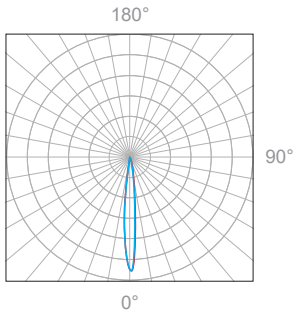

Beam Width: 12°



Illuminance at a Distance

| Distance | | Center Beam fc | Beam Width | | | |
|----------|-------|----------------|------------|-------|-------|-------|
| 3.0ft | 0.91m | 506fc | 0.6ft | 0.18m | 0.6ft | 0.18m |
| 6.0ft | 1.83m | 126fc | 1.3ft | 0.39m | 1.3ft | 0.39m |
| 9.0ft | 2.74m | 56.2fc | 1.9ft | 0.58m | 1.9ft | 0.58m |
| 12.0ft | 3.66m | 31.6fc | 2.5ft | 0.76m | 2.6ft | 0.79m |
| 15.0ft | 4.57m | 20.2fc | 3.1ft | 0.94m | 3.2ft | 0.97m |
| 18.0ft | 5.49m | 14fc | 3.8ft | 1.15m | 3.9ft | 1.18m |

Delivered Lumen: 398.4 lm
■ Vertical Beam Spread: 11.9°
■ Horizontal Beam Spread: 12.3°

**Polar Candela Distribution
NA (No Accessories)**

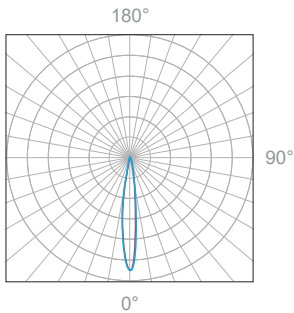

Beam Width: 15°



Illuminance at a Distance

| Distance | | Center Beam fc | Beam Width | | | |
|----------|-------|----------------|------------|-------|-------|-------|
| 3.0ft | 0.91m | 403fc | 0.7ft | 0.21m | 0.6ft | 0.21m |
| 6.0ft | 1.83m | 101fc | 1.5ft | 0.45m | 1.3ft | 0.45m |
| 9.0ft | 2.74m | 44.8fc | 2.2ft | 0.67m | 2.2ft | 0.67m |
| 12.0ft | 3.66m | 25.2fc | 3.0ft | 0.91m | 3.0ft | 0.91m |
| 15.0ft | 4.57m | 16.1fc | 3.7ft | 1.12m | 3.7ft | 1.12m |
| 18.0ft | 5.49m | 11.2fc | 4.5ft | 1.37m | 4.4ft | 1.34m |

Delivered Lumen: 393.7 lm
■ Vertical Beam Spread: 14.2°
■ Horizontal Beam Spread: 14.1°

**Polar Candela Distribution
NA (No Accessories)**

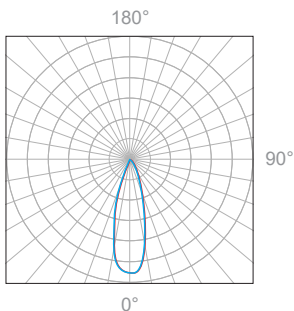

Beam Width: 26°

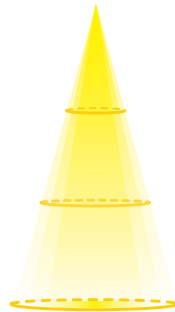

Illuminance at a Distance

| Distance | | Center Beam fc | Beam Width | | | |
|----------|-------|----------------|------------|-------|-------|-------|
| 3.0ft | 0.91m | 195fc | 1.4ft | 0.42m | 1.3ft | 0.39m |
| 6.0ft | 1.83m | 48.9fc | 2.7ft | 0.82m | 2.7ft | 0.82m |
| 9.0ft | 2.74m | 21.7fc | 4.1ft | 1.25m | 4.0ft | 1.22m |
| 12.0ft | 3.66m | 12.2fc | 5.4ft | 1.64m | 5.3ft | 1.61m |
| 15.0ft | 4.57m | 7.82fc | 6.8ft | 2.07m | 6.6ft | 2.01m |
| 18.0ft | 5.49m | 5.43fc | 8.2ft | 2.50m | 8.0ft | 2.43m |

Delivered Lumen: 397.8 lm
■ Vertical Beam Spread: 25.6°
■ Horizontal Beam Spread: 25.0°

**Polar Candela Distribution
NA (No Accessories)**

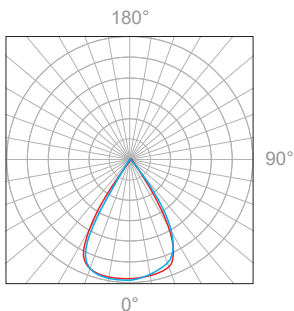

Beam Width: 45°

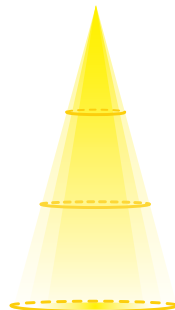

Illuminance at a Distance

| Distance | | Center Beam fc | Beam Width | | | |
|----------|-------|----------------|------------|-------|--------|-------|
| 3.0ft | 0.91m | 34.8fc | 3.8ft | 1.15m | 3.8ft | 1.15m |
| 6.0ft | 1.83m | 8.71fc | 7.6ft | 2.31m | 7.6ft | 2.31m |
| 9.0ft | 2.74m | 3.87fc | 11.4ft | 3.47m | 11.4ft | 3.47m |
| 12.0ft | 3.66m | 2.18fc | 15.2ft | 4.63m | 15.2ft | 4.63m |
| 15.0ft | 4.57m | 1.39fc | 19.0ft | 5.79m | 19.0ft | 5.79m |
| 18.0ft | 5.49m | 0.94fc | 22.8ft | 6.95m | 22.8ft | 6.95m |

Delivered Lumen: 360.4 lm
■ Vertical Beam Spread: 64.7°
■ Horizontal Beam Spread: 64.6°

Appendix

Aluminum Finishes



MA matte clear anodized
NA no accessories



BA black anodized
NA no accessories

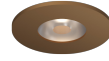

BZ bronze powder coated
NA no accessories

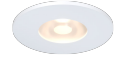

WH white powder coated
NA no accessories



MA matte clear anodized
SH metal shroud, silver