

# L632

*Interior pendant*

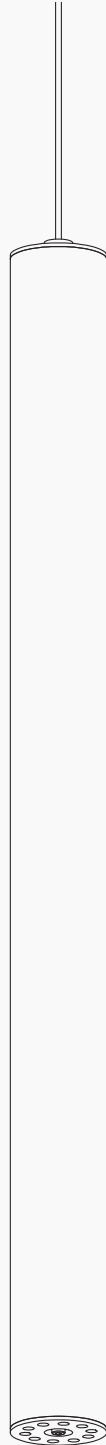

# L632

Interior pendant

## Parts

- LED unit x 1
- Canopy x 1
- Mounting Bracket
- Socket head screws x 14
- Safety Cables
- Mounting fasteners (not provided)

- 1) Connect fixture wires to low voltage wiring (Remote Driver)
- 2) Align bracket to electrical box for electrical wires to pass.
- 3) It is necessary that fixture is secured to wood blocking (not provided) to support approximately 50 lbs.
- 4) Mount bracket to the wood blocking with fasteners (not provided).
- 5) Use anchor wires to secure canopy to mounting bracket for extra support.
- 6) Align canopy to bracket and tighten screws (provided) on all side.

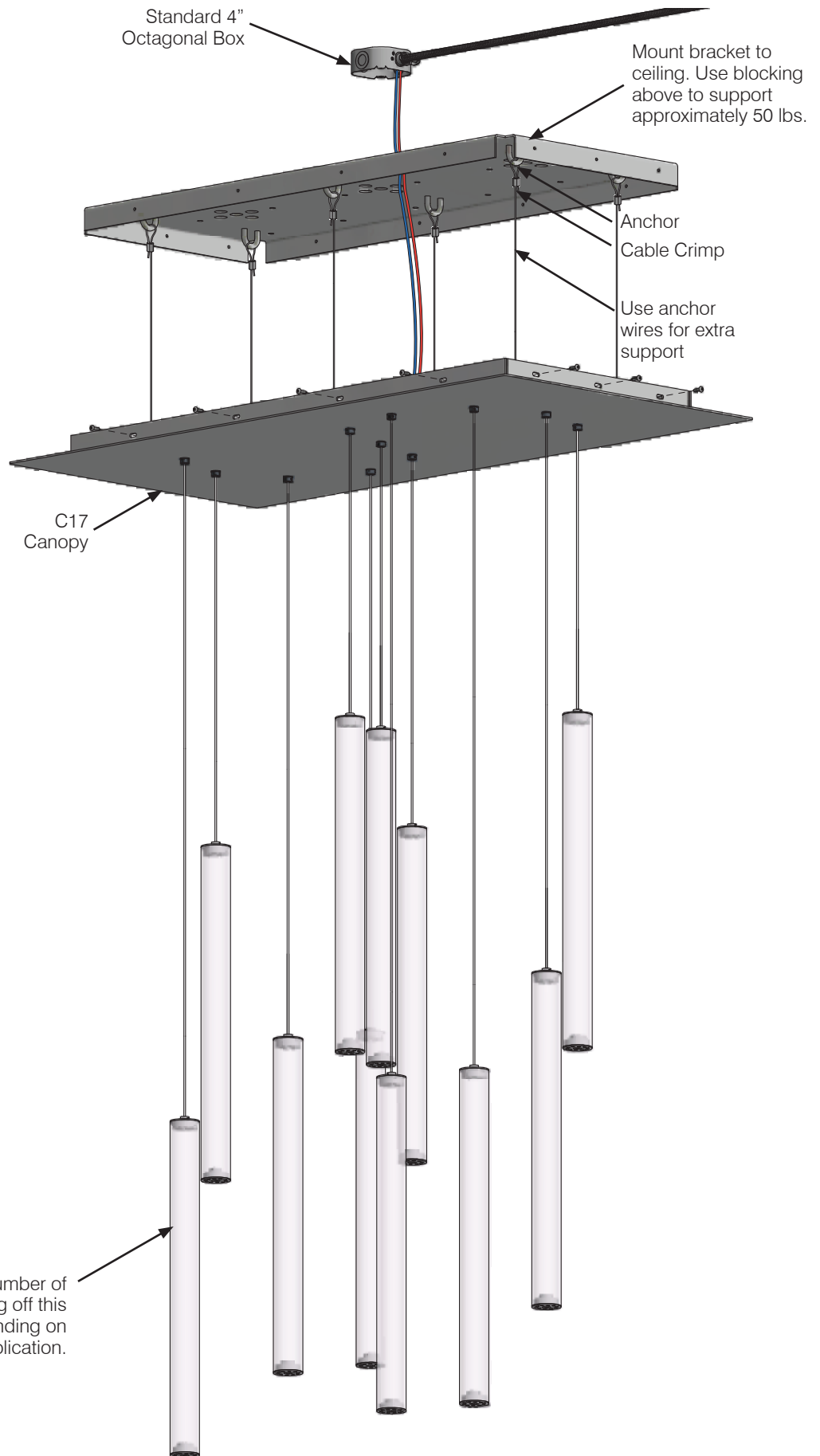

# L632

*Interior pendant*

- 1) Cut coax wire to desired length.
- 2) Unbraid outer woven wire to expose 1/2" (13mm) of inner wire. Twist outer strands tightly together.
- 3) Strip 1/8" (3mm) of insulation from inner wire.
- 4) Remove setscrew on canopy.
- 5) Make sure strain relief is in place in the center hole and pull wire through canopy.
- 6) Tighten setscrew when pendant is adjusted to desired height.

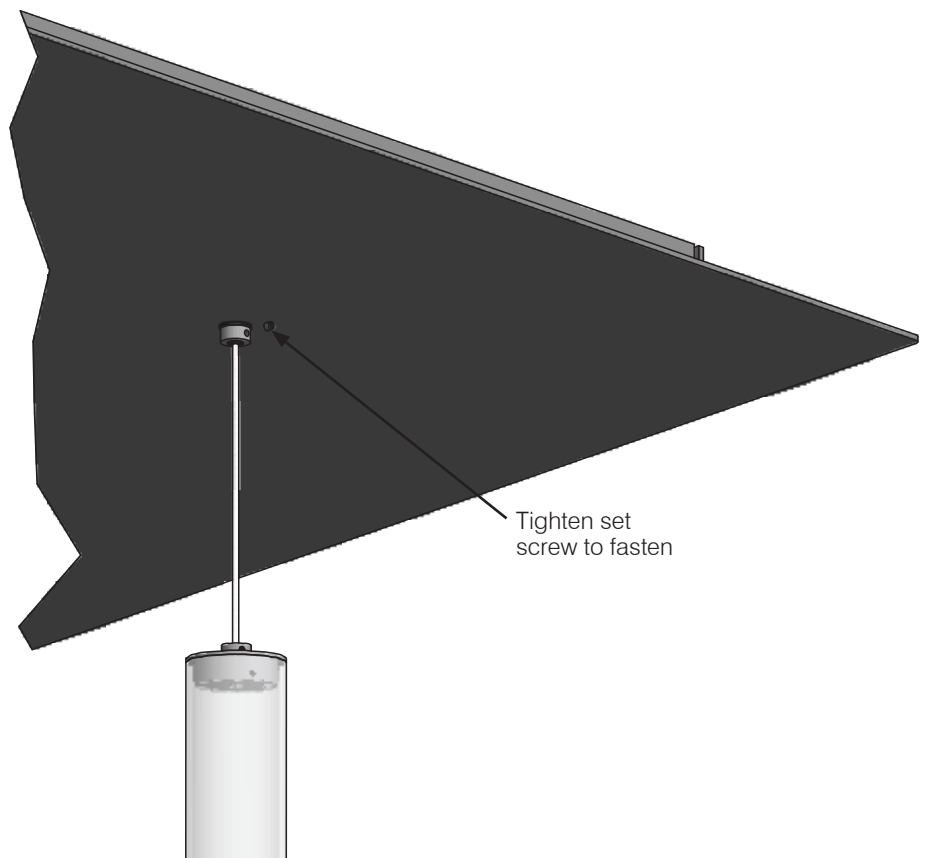
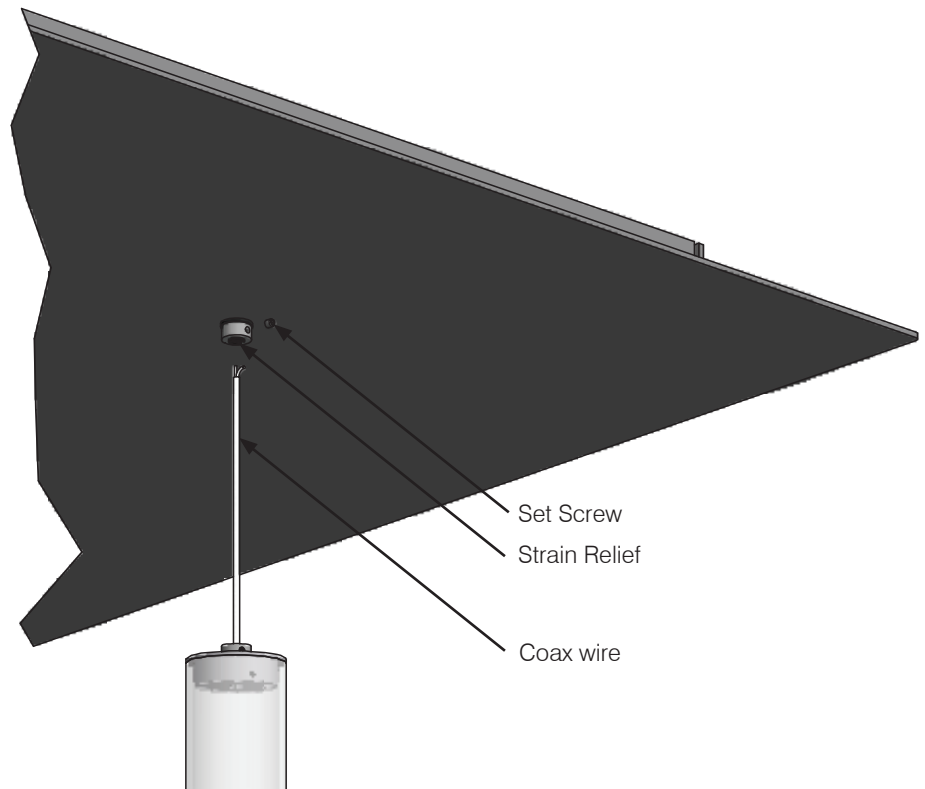

## IMPORTANT SAFETY INSTRUCTIONS

KEEP THESE INSTALLATION INSTRUCTIONS

(Including General and Additional Markings for Fixtures)

(FOR MP LIGHTING LED LUMINAIRES, CLASS 3402-xx)

General and additional markings

1. For Use Only with Certified/NRTL Driver, Model \_\_\_\_\_
2. DRY LOCATIONS ONLY

Installation instructions

1. The grounding installation shall be done in accordance with CEC-Part 1.
2. WARNING: RISK OF FIRE OR ELECTRIC SHOCK: DO NOT MAKE OR ALTER ANY OPENINGS IN THE COMPARTMENT OF WIRING OR ELECTRICAL COMPONENTS DURING INSTALLATION. DO NOT ALTER OR ADD BALLASTS, OR ANY OTHER ELECTRICAL COMPONENTS.
3. INSTALLATION AND USE OF THIS FIXTURE MOUNTING ASSEMBLY REQUIRES A PERSON FAMILIAR WITH THE CONSTRUCTION AND OPERATION OF LUMINAIRE ELECTRICAL SYSTEMS AND THE HAZARD INVOLVED, IF NOT QUALIFIED, DO NOT ATTEMPT INSTALLATION. CONTACT A QUALIFIED ELECTRICIAN.
4. TURN OFF POWER BEFORE INSTALLATION.
5. KEEP THESE INSTALLATION INSTRUCTIONS.

## CONSIGNES DE SÉCURITÉ IMPORTANTES

CONSERVER CES INSTRUCTIONS D'INSTALLATION

(Dont le général et marques supplémentaires pour les appareils)

(Pour les luminaires LED MP D'ÉCLAIRAGE , CLASS 3402 -xx )

Général et marquages supplémentaires

1. A utiliser uniquement avec Certified / NRTL pilote, modèle \_\_\_\_\_
2. POUR EMPLACEMENTS SECS SEULEMENT

Les instructions d'installation

1. L'installation de mise à la terre doit être fait en conformité avec CEC Partie 1.
2. AVERTISSEMENT : RISQUE D'INCENDIE OU D'ÉLECTROCUTION : NE PAS FAIRE OU MODIFIER DES OUVERTURES DANS LE COMPARTIMENT DE CÂBLAGE OU DE COMPOSANTS ÉLECTRIQUES LORS DE L'INSTALLATION. NE PAS MODIFIER OU AJOUTER DES BALLASTS, OU AUTRES COMPOSANTS ÉLECTRIQUES
3. CE PRODUIT DOIT ÊTRE INSTALLÉ SELON LE CODE D'INSTALLATION PERTINENT, PAR UNE PERSONNE QUI CONNAÎT BIEN LE PRODUIT ET SON FONCTIONNEMENT AINSI QUE LES RISQUES INHÉRENTS. CONSULTER UN ÉLECTRICIEN QUALIFIÉ.
4. COUPER LE COURANT AVANT L'INSTALLATION.
5. CONSERVEZ CES INSTRUCTIONS.