

# L641

## INTERIOR

Pendant System | Composed of L195 X 7

● Dry location



### Ordering Information

Clear Form

Date : \_\_\_\_\_

Quantity : \_\_\_\_\_

Project : \_\_\_\_\_

Note : \_\_\_\_\_

Type : \_\_\_\_\_

### Specifications

Luminaire | Example Code: L641-2-C11-2-W30H-N-C72-BK

Product	Version	Mounting Option	Length	CCT & CRI <sup>1</sup>	Beam Angle	Cord <sup>2</sup>	Hardware Finish
<b>L641</b>		<b>C11</b>					<b>BK</b>
	1 1W 2 2W	<b>C11</b> square canopy: 30" X 30" (762mm X 762mm)	<b>A</b> 1/2' (6.5") 1 1' 2 2' 4 4' 6 6"	<b>W22S</b> 2200K 80+ <b>W27H</b> 2700K 90+ <b>W30H</b> 3000K 90+ <b>W35H</b> 3500K 90+ <b>W41H</b> 4100K 90+	<b>S</b> spot 12° <b>N</b> narrow flood 30°	<b>C72</b> 72" (1829mm) <b>CX</b> custom	<b>BK</b> black powder coated

### System Components (Ordered Separately)

Remote Driver : \_\_\_\_\_

\* Consult MP Lighting Website or Factory.

### Important Notes

#### Specification

1. Refer to pg.2 - for light quality and colour consistency details.
2. Minimum: 6" (152mm) Maximum: 8' (2439mm), 1" (25mm) increments.

#### Warranty Notes & Disclaimer

Malfunction and damage to product due to incompatible dimming system or misuse will not be covered under warranty. Consult MP Lighting for recommended drivers. If the fixture has an option to be installed with a dimming control system, consult a dimming system manufacturer with minimum load before installing. MP Lighting reserves the right, at its sole discretion, at any time and without notice, to make design changes to any of our products. Consult MP Lighting website for most updated documentation.

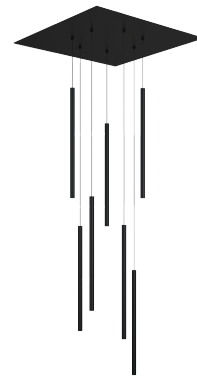

# L641

## INTERIOR

Pendant System | Composed of L195 X 7

● Dry location



### Performance | Each pendant (L195)

Wattage	Forward Current	Power Consumption Budget per fixture (including driver)	LED output (Source)	Fixture Output (Delivered)
1W	350mA	1.3W	110 lm	47-56 lm
2W	700mA	2.6W	220 lm	90-99 lm

### Application

Environment	Dry Location approved. IP 20.
Mounting	C11 canopy retrofit to a 4" octagonal box using the mounting plate (included)

### Electrical

Power Supplies	Remote LED drivers (120-277V AC input, <b>constant current output</b> ): Fixtures to be wired in series.
Control	<b>On/off control</b> <b>Dimming:</b> ELV or 0-10V dimming with appropriate drivers <b>Other options (consult factory):</b> TRIAC/MLV, DMX, DALI, Casambi, Power over Ethernet

### Luminaire Construction

LED Light Source	<b>W22S</b> = CCT: 2200K, CRI (Ra): 80+, Colour Consistency: 3SDCM <b>W27H</b> = CCT: 2700K, CRI (Ra): 90+, Colour Consistency: 2SDCM <b>W30H</b> = CCT: 3000K, CRI (Ra): 90+, Colour Consistency: 2SDCM <b>W35H</b> = CCT: 3500K, CRI (Ra): 90+, Colour Consistency: 2SDCM <b>W41H</b> = CCT: 4100K, CRI (Ra): 90+, Colour Consistency: 3SDCM
Standard Compliance	✓ WELL standard – Feature 58: Color Quality
Weight	N/A
Material	<b>Fixture &amp; Hardware:</b> Machined marine-grade aluminum
Supplied with	<b>Standard installation housing:</b> Comes with a canopy, mounting bracket, socket head screws (10), safety cables. Not included: mounting fasteners <b>Cord:</b> 72" (1829mm) cord is included. Consult factory for custom cord length.
Warranty & LED Life	5 years limited warranty Estimated useful life of LED is 50,000 hours.

### Ordered Separately

System Components	<b>Power supplies:</b> remote driver Please consult factory or visit <a href="#">Recommended Drivers</a> for available driver options.
-------------------	---

Mounting Options & Dimensions

LED Fixture Dimensions

Fixture: Individual L195

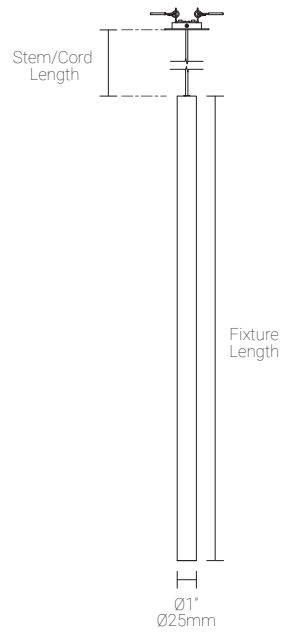

Fixture: L641

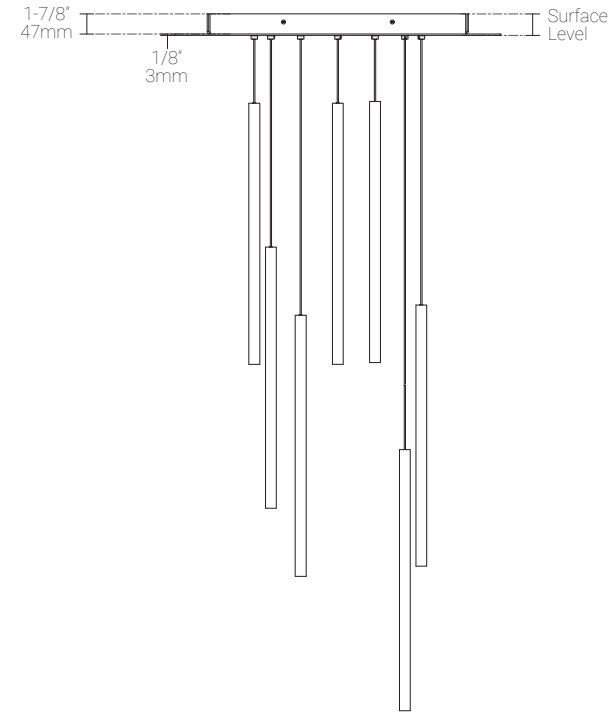

3D View

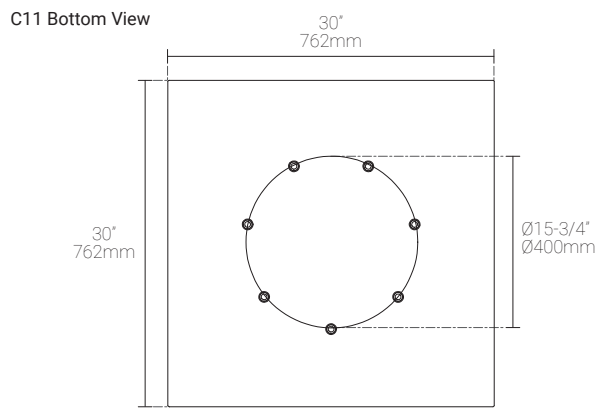
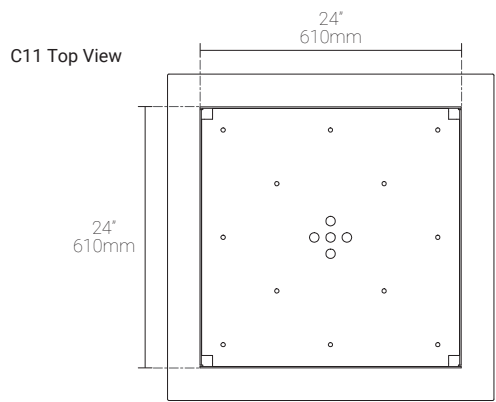
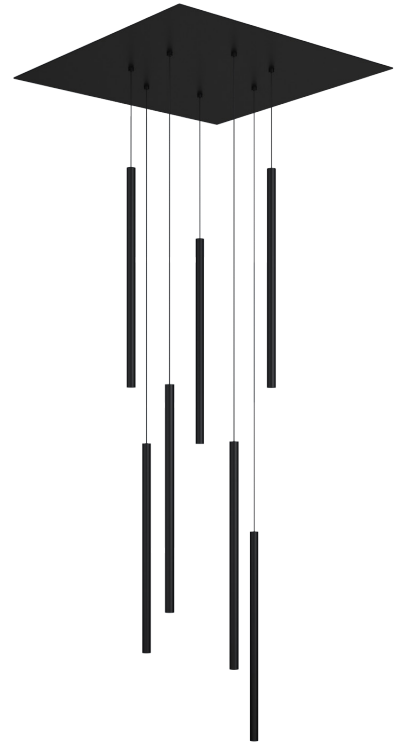

L195 | 1W, 3000K, 90+ CRI

Polar Candela Distribution

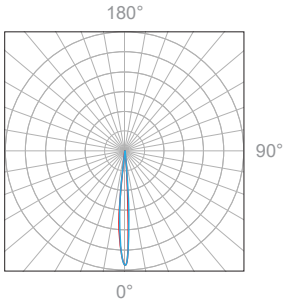

Beam Width: 12°

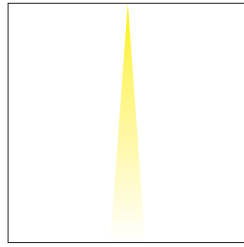

Illuminance at a Distance

Distance		Center Beam fc
1.5ft	0.46m	170.7fc
3.0ft	0.91m	43.7fc
6.0ft	1.83m	10.7fc
9.0ft	2.74m	4.9fc
12.0ft	3.66m	2.8fc
15.0ft	4.57m	1.8fc

Delivered Lumen: 48.7lm  
■ Vertical Beam Spread: 19.9°  
■ Horizontal Beam Spread: 19.9°

Polar Candela Distribution

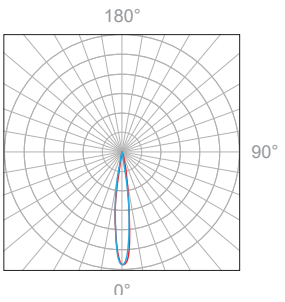

Beam Width: 30°

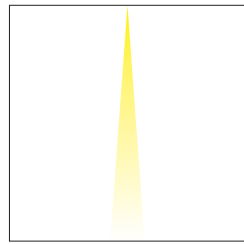

Illuminance at a Distance

Distance		Center Beam fc
1.5ft	0.46m	106.7fc
3.0ft	0.91m	27.7fc
6.0ft	1.83m	7.0fc
9.0ft	2.74m	3.1fc
12.0ft	3.66m	1.8fc
15.0ft	4.57m	1.2fc

Delivered Lumen: 55.9lm  
■ Vertical Beam Spread: 28.3°  
■ Horizontal Beam Spread: 28.3°

L195 | 2W, 3000K, 90+ CRI

Polar Candela Distribution

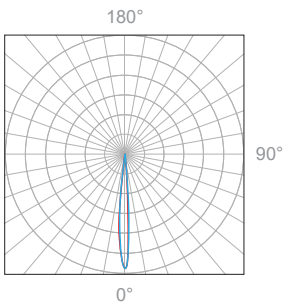

Beam Width: 12°

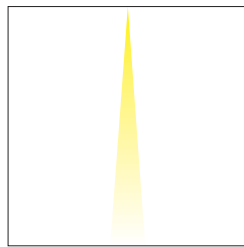

Illuminance at a Distance

Distance		Center Beam fc
1.5ft	0.46m	288.1fc
3.0ft	0.91m	76.8fc
6.0ft	1.83m	19.2fc
9.0ft	2.74m	8.5fc
12.0ft	3.66m	4.8fc
15.0ft	4.57m	3.1fc

Delivered Lumen: 89.6lm  
■ Vertical Beam Spread: 19.9°  
■ Horizontal Beam Spread: 19.9°

Polar Candela Distribution

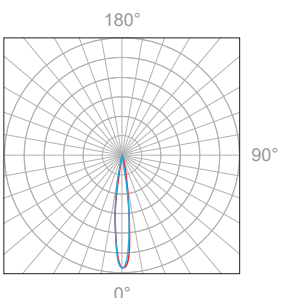

Beam Width: 30°

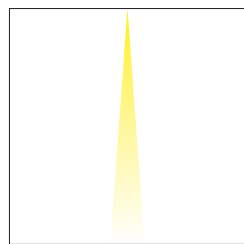

Illuminance at a Distance

Distance		Center Beam fc
1.5ft	0.46m	197.4fc
3.0ft	0.91m	50.1fc
6.0ft	1.83m	12.8fc
9.0ft	2.74m	5.7fc
12.0ft	3.66m	3.2fc
15.0ft	4.57m	3.1fc

Delivered Lumen: 98.8lm  
■ Vertical Beam Spread: 28.3°  
■ Horizontal Beam Spread: 28.3°

Full Spectrum

— Full Spectrum — Standard Illuminant @ 3000K — Ra≥80

