

L662

INTERIOR

Pendant | For ceilings

● Dry location



Shown with Clear Globe

Ordering Information

Clear Form

Date : _____

Quantity : _____

Project : _____

Note : _____

Type : _____

Specifications

Luminaire | Example Code: L662-1CT-2-W30H-C-C72-BA

| Product | Canopy ¹ | Version | CCT & CRI ² | Acrylic Globe | Cord Length ³ | Finish (Mounting Hardware) |
|---------|---------------------|---------|------------------------|---------------|--------------------------|---|
| L662 | 1CT | 1 1W | W22S 2200K 80+ | C clear | Cord: | BA black anodized WH white powder coated |
| | | 2 2W | W27H 2700K 90+ | F frosted | C72 72" (1830mm) | |
| | | | W30H 3000K 90+ | | CX custom length | |
| | | | W35H 3500K 90+ | | | |
| | | | W41H 4100K 90+ | | | |

System Components (Ordered Separately)

Remote Driver : _____

* Consult MP Lighting Website or Factory.

Important Notes

Specification

1. Refer to pg.3 for track dimensions.
2. Refer to pg.2 - Electrical - for Colour Consistency details.
3. 72" (1830mm) cord is included. Consult factory for custom cord length.

Warranty Notes & Disclaimer

Malfunction and damage to product due to incompatible dimming system or misuse will not be covered under warranty. Consult MP Lighting for recommended drivers. If the fixture has an option to be installed with a dimming control system, consult a dimming system manufacturer with minimum load before installing. MP Lighting reserves the right, at its sole discretion, at any time and without notice, to make design changes to any of our products. Consult MP Lighting website for most updated documentation.

L662

INTERIOR

Pendant | For ceilings

● Dry location



Shown with Clear Globe

Performance

| Wattage | Forward Current | Power Consumption Budget per fixture (including driver) | LED output (Source) | Fixture Output (Delivered) |
|---------|-----------------|---|---------------------|----------------------------|
| 1W | 350mA | 1.3W | 110 lm | 55.3 lm |
| 2W | 700mA | 2.6W | 220 lm | 109.4 lm |

Application

| | |
|-------------|---|
| Environment | Dry Location approved. IP 20. |
| Mounting | Mounts to 1CT Track (adapter included). |

Electrical

| | |
|----------------|---|
| Power Supplies | Remote LED drivers (120-277V AC input, constant current output): Fixtures to be wired in series. |
| Control | <p>On/off control</p> <p>Dimming: ELV or 0-10V dimming with appropriate drivers</p> <p>Other options (consult factory): TRIAC/MLV, DMX, DALI, Casambi, Power over Ethernet</p> |

Luminaire Construction

| | |
|---------------------|---|
| LED Light Source | <p>W22S = CCT: 2200K, CRI (Ra): 80+, Colour Consistency: 3SDCM</p> <p>W27H = CCT: 2700K, CRI (Ra): 90+, Colour Consistency: 2SDCM</p> <p>W30H = CCT: 3000K, CRI (Ra): 90+, Colour Consistency: 2SDCM</p> <p>W35H = CCT: 3500K, CRI (Ra): 90+, Colour Consistency: 2SDCM</p> <p>W41H = CCT: 4100K, CRI (Ra): 90+, Colour Consistency: 3SDCM</p> |
| Weight | N/A |
| Material | <p>Fixture: acrylic globe</p> <p>Fixture holder (pendant hardware): machined marine-grade aluminum</p> |
| Supplied with | Standard installation housing |
| Warranty & LED Life | <p>5 years limited warranty</p> <p>Estimated useful life of LED is 50,000 hours.</p> |

Ordered Separately

| | |
|-------------------|--|
| System Components | <p>Power supplies: remote driver</p> <p>Please consult factory or visit Recommended Drivers for available driver options.</p> |
|-------------------|--|

Mounting Options & Dimensions

LED Fixture Dimensions

Fixture

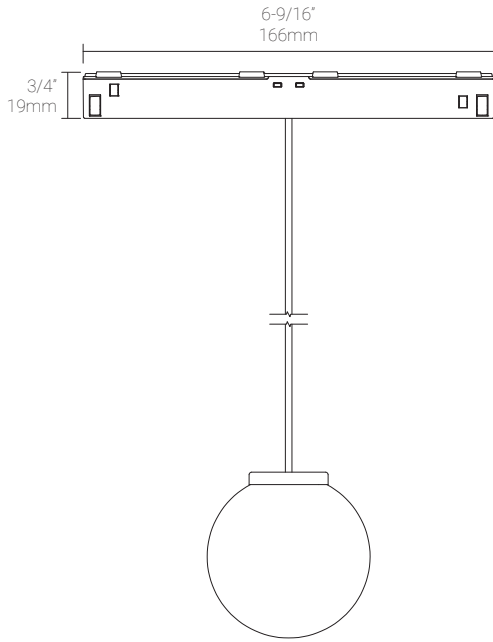

Front View

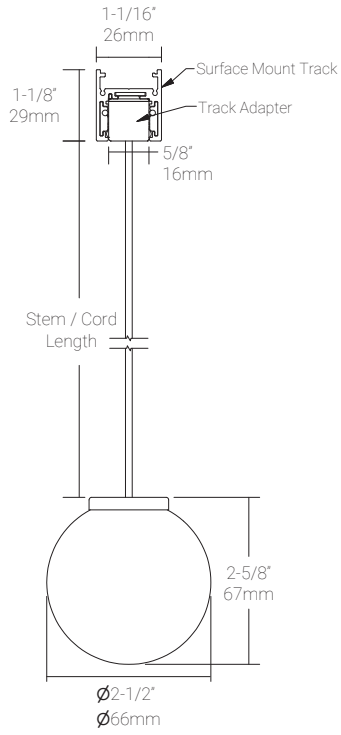

3D View



1W, 3000K, 90+ CRI

Clear Globe

Polar Candela Distribution

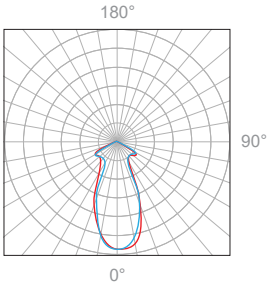

Beam Width: 38°

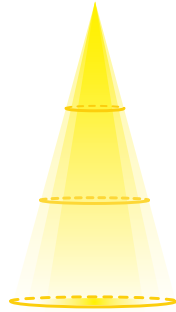

Illuminance at a Distance

| Distance | | Center Beam fc | Beam Width | | | |
|----------|-------|----------------|------------|-------|--------|-------|
| 3.0ft | 0.91m | 8.04fc | 2.3ft | 0.70m | 2.0ft | 0.61m |
| 6.0ft | 1.83m | 2.01fc | 4.5ft | 1.37m | 4.0ft | 1.22m |
| 9.0ft | 2.74m | 0.89fc | 6.8ft | 2.07m | 6.1ft | 1.86m |
| 12.0ft | 3.66m | 0.50fc | 9.1ft | 2.77m | 8.1ft | 2.46m |
| 15.0ft | 4.57m | 0.32fc | 11.3ft | 3.44m | 10.1ft | 3.07m |
| 18.0ft | 5.49m | 0.22fc | 13.6ft | 4.14m | 12.1ft | 3.68m |

Delivered Lumen: 90 lm
 ■ Vertical Beam Spread: 41.3°
 ■ Horizontal Beam Spread: 37.3°

Frosted Globe

Polar Candela Distribution

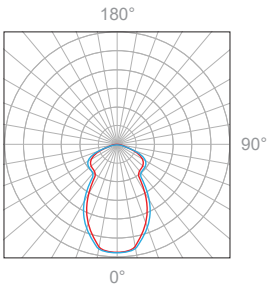

Beam Width: 70°

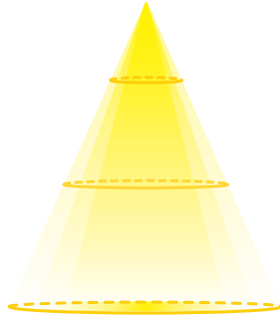

Illuminance at a Distance

| Distance | | Center Beam fc | Beam Width | | | |
|----------|-------|----------------|------------|-------|--------|-------|
| 3.0ft | 0.91m | 3.04fc | 4.2ft | 1.28m | 3.8ft | 1.15m |
| 6.0ft | 1.83m | 0.76fc | 8.3ft | 2.53m | 7.5ft | 2.18m |
| 9.0ft | 2.74m | 0.34fc | 12.5ft | 3.81m | 11.3ft | 3.44m |
| 12.0ft | 3.66m | 0.19fc | 16.7ft | 5.09m | 15.1ft | 4.60m |
| 15.0ft | 4.57m | 0.12fc | 20.8ft | 6.34m | 18.9ft | 5.76m |
| 18.0ft | 5.49m | 0.08fc | 25.0ft | 7.62m | 22.6ft | 1.28m |

Delivered Lumen: 66.8 lm
 ■ Vertical Beam Spread: 69.5°
 ■ Horizontal Beam Spread: 64.3°

2W, 3000K, 90+ CRI

Clear Globe

Polar Candela Distribution

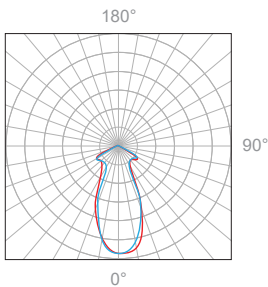

Beam Width: 38°

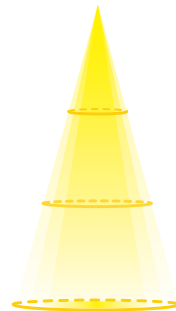

Illuminance at a Distance

| Distance | | Center Beam fc | Beam Width | | | |
|----------|-------|----------------|------------|-------|--------|-------|
| 3.0ft | 0.91m | 14.5fc | 2.2ft | 0.67m | 1.9ft | 0.58m |
| 6.0ft | 1.83m | 3.62fc | 4.4ft | 1.34m | 3.9ft | 1.18m |
| 9.0ft | 2.74m | 1.61fc | 6.6ft | 2.01m | 5.8ft | 1.76m |
| 12.0ft | 3.66m | 0.90fc | 8.8ft | 2.68m | 7.8ft | 2.37m |
| 15.0ft | 4.57m | 0.58fc | 11.0ft | 3.35m | 9.7ft | 2.95m |
| 18.0ft | 5.49m | 0.40fc | 13.2ft | 4.02m | 11.7ft | 3.56m |

Delivered Lumen: 159 lm
 ■ Vertical Beam Spread: 40.4°
 ■ Horizontal Beam Spread: 35.9°

Frosted Globe

Polar Candela Distribution

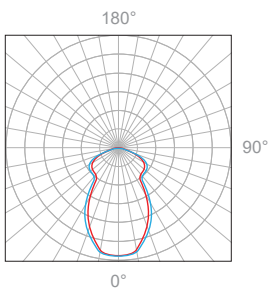

Beam Width: 70°

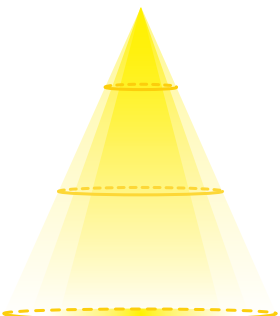

Illuminance at a Distance

| Distance | | Center Beam fc | Beam Width | | | |
|----------|-------|----------------|------------|-------|--------|-------|
| 3.0ft | 0.91m | 5.36fc | 4.3ft | 1.31m | 4.1ft | 1.24m |
| 6.0ft | 1.83m | 1.34fc | 8.6ft | 2.62m | 8.3ft | 2.53m |
| 9.0ft | 2.74m | 0.60fc | 12.9ft | 3.93m | 12.4ft | 3.78m |
| 12.0ft | 3.66m | 0.33fc | 17.2ft | 5.24m | 16.5ft | 5.03m |
| 15.0ft | 4.57m | 0.21fc | 21.4ft | 6.52m | 20.6ft | 6.27m |
| 18.0ft | 5.49m | 0.15fc | 25.7ft | 7.83m | 24.8ft | 7.56m |

Delivered Lumen: 120.7 lm
 ■ Vertical Beam Spread: 71.1°
 ■ Horizontal Beam Spread: 69.0°

Appendix

Acrylic Globe



Clear



Frosted

Hardware Finishes



BA black anodized



WH white powder coated