

L698C22

Interior pendant

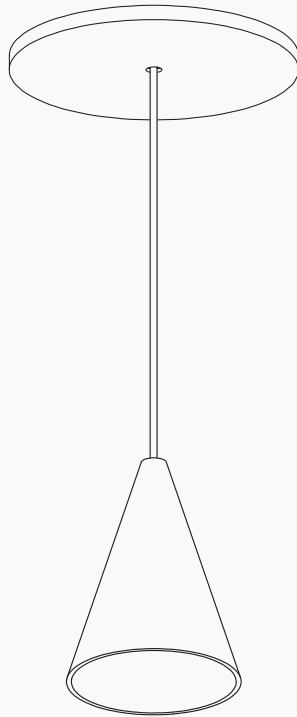

L698C22

Interior pendant

Parts

LED fixture
Canopy
Wire connectors
Mounting bracket and hardware

- 1) Join adapter to the mounting bracket. Secure with nut.
- 2) Feed the cable wire through the canopy and adapter. Adjust to desired length. Leave at least 6" (152mm) of cable past the bracket.
- 3) Secure the cable using strain relief. Tighten with set screw.

**Do not overtighten set screw.
This may damage the cable
and cause a short circuit.*

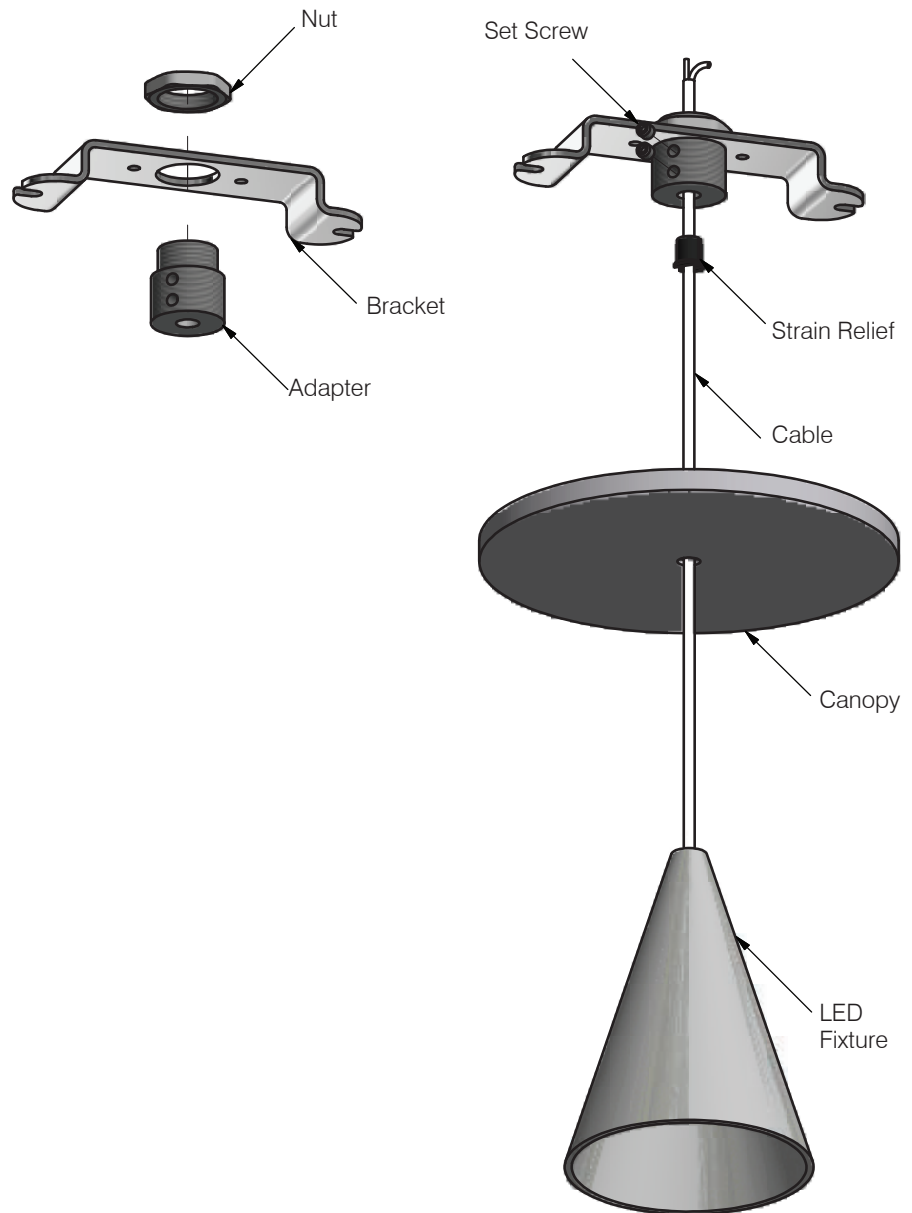

L698C22

Interior pendant

Parts

LED fixture

Canopy

Wire connectors

Mounting bracket and hardware

- 1) Unbraid outer woven wire to expose 1/2" (13mm) of inner wire. Twist outer strands tightly together.
- 2) Strip 1/8" (3mm) of insulation from inner wire
- 3) Mount bracket to electrical box using two screws.
- 4) Connect braided coax wire to low voltage wiring (remote LED driver). The power to the driver must be off while wiring LED fixtures to drivers.

**Connecting LEDs to a live driver will cause LEDs to fail.*

- 5) Mount the canopy by threading it to the adapter.

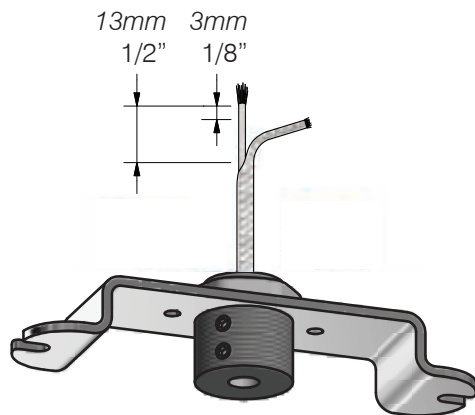
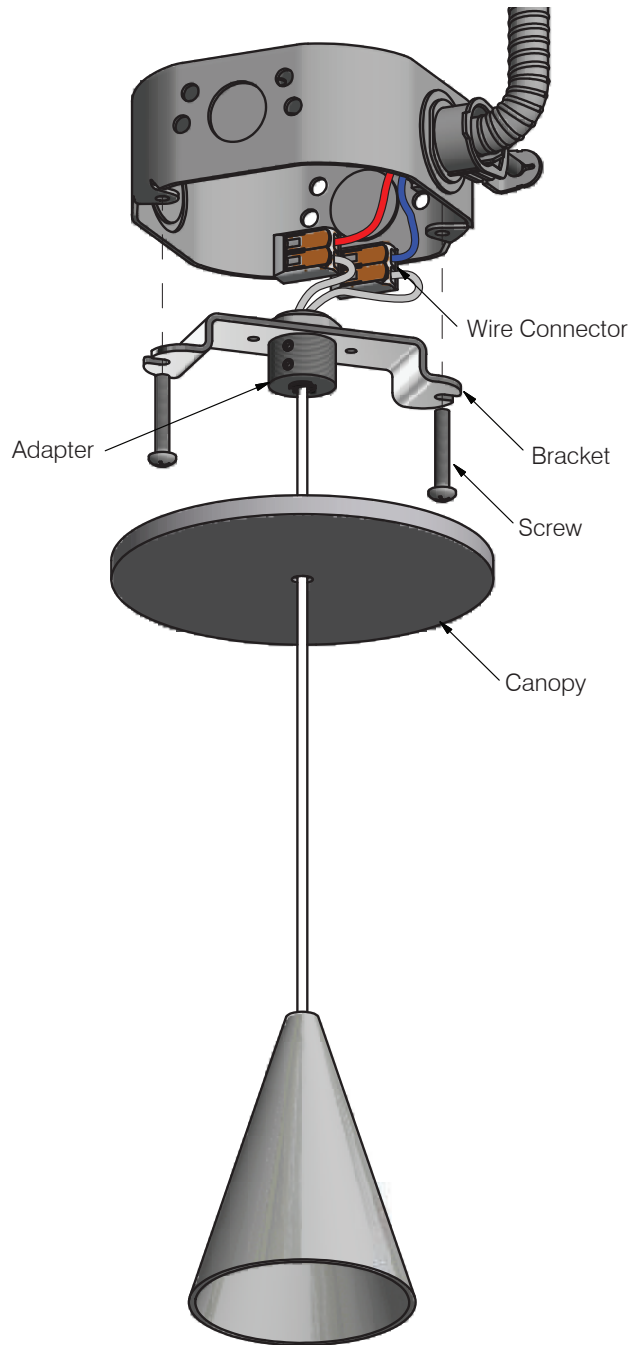

IMPORTANT SAFETY INSTRUCTIONS

KEEP THESE INSTALLATION INSTRUCTIONS

(Including General and Additional Markings for Fixtures)

(FOR MP LIGHTING LED LUMINAIRES, CLASS 3402-xx)

General and additional markings

1. For Use Only with Certified/NRTL Driver, Model _____
2. DRY LOCATIONS ONLY

Installation instructions

1. The grounding installation shall be done in accordance with CEC-Part 1.
2. WARNING: RISK OF FIRE OR ELECTRIC SHOCK: DO NOT MAKE OR ALTER ANY OPENINGS IN THE COMPARTMENT OF WIRING OR ELECTRICAL COMPONENTS DURING INSTALLATION. DO NOT ALTER OR ADD BALLASTS, OR ANY OTHER ELECTRICAL COMPONENTS.
3. INSTALLATION AND USE OF THIS FIXTURE MOUNTING ASSEMBLY REQUIRES A PERSON FAMILIAR WITH THE CONSTRUCTION AND OPERATION OF LUMINAIRE ELECTRICAL SYSTEMS AND THE HAZARD INVOLVED, IF NOT QUALIFIED, DO NOT ATTEMPT INSTALLATION. CONTACT A QUALIFIED ELECTRICIAN.
4. TURN OFF POWER BEFORE INSTALLATION.
5. KEEP THESE INSTALLATION INSTRUCTIONS.

CONSIGNES DE SÉCURITÉ IMPORTANTES

CONSERVER CES INSTRUCTIONS D'INSTALLATION

(Dont le général et marques supplémentaires pour les appareils)

(Pour les luminaires LED MP D'ÉCLAIRAGE , CLASS 3402 -xx)

Général et marquages supplémentaires

1. A utiliser uniquement avec Certified / NRTL pilote, modèle _____
2. POUR EMPLACEMENTS SECS SEULEMENT

Les instructions d'installation

1. L'installation de mise à la terre doit être fait en conformité avec CEC Partie 1.
2. AVERTISSEMENT : RISQUE D'INCENDIE OU D'ÉLECTROCUTION : NE PAS FAIRE OU MODIFIER DES OUVERTURES DANS LE COMPARTIMENT DE CÂBLAGE OU DE COMPOSANTS ÉLECTRIQUES LORS DE L'INSTALLATION. NE PAS MODIFIER OU AJOUTER DES BALLASTS, OU AUTRES COMPOSANTS ÉLECTRIQUES
3. CE PRODUIT DOIT ÊTRE INSTALLÉ SELON LE CODE D'INSTALLATION PERTINENT, PAR UNE PERSONNE QUI CONNAÎT BIEN LE PRODUIT ET SON FONCTIONNEMENT AINSI QUE LES RISQUES INHÉRENTS. CONSULTER UN ÉLECTRICIEN QUALIFIÉ.
4. COUPER LE COURANT AVANT L'INSTALLATION.
5. CONSERVEZ CES INSTRUCTIONS.