

L714

INTERIOR

Wall-mount | For walls, stairs, and walkways

● Dry location



Vertical



Horizontal

Ordering Information

Clear Form

Date : _____

Quantity : _____

Project : _____

Note : _____

Type : _____

Specifications

Luminaire | Example Code: L714-2-W30H-W-V-MA

Product	Version	CCT & CRI ¹	Beam Angle	Plate	Mounting Kit ² (optional)	Trim Finish
L714						MA
	1 1W 2 2W	W22S 2200K 80+ W27H 2700K 90+ W30H 3000K 90+ W35H 3500K 90+ W41H 4100K 90+	S spot 12° N narrow flood 30° F flood 45° W wide flood 120°	V vertical H horizontal	MK1 vertical surface	MA matte clear anodized

System Components (Ordered Separately)

Remote Driver : _____

* Consult MP Lighting Website or Factory.

Important Notes

Specification

1. Refer to pg.2 - for Light quality and colour consistency details.
2. Mounting kit is ordered separately (consult factory). Back box must also be purchased with MK1 kit.

Warranty Notes & Disclaimer

Malfunction and damage to product due to incompatible dimming system or misuse will not be covered under warranty. Consult MP Lighting for recommended drivers. If the fixture has an option to be installed with a dimming control system, consult a dimming system manufacturer with minimum load before installing. MP Lighting reserves the right, at its sole discretion, at any time and without notice, to make design changes to any of our products. Consult MP Lighting website for most updated documentation.

L714

INTERIOR

Wall-mount | For walls, stairs, and walkways

● Dry location



Vertical



Horizontal

Performance

Wattage	Forward Current	Power Consumption Budget per fixture (including driver)	LED output (Source)	Fixture Output (Delivered)
1W	350mA	1.3W	110 lm	72-90 lm
2W	700mA	2.6W	220 lm	130-163 lm

Application

Environment	Dry Location approved. IP 50.
Mounting	Mounts to single gang box (ordered separately). Box opening: Width 2-3/8" (60.33mm) X Height 2" (50.8mm) Optimal mounting distance: 18"-24" (457mm-610mm) AFF. MK1 mounting kit (optional): Recommended for easy installation on vertical surfaces (e.g. stair risers, walls). See "Mounting Options & Dimensions, " or visit MK1

Electrical

Power Supplies	Non-dimmable integral driver included (100-240V AC input). Compatible with remote driver for wet locations (not included).
Control	On/off control Dimming (consult factory): ELV or 0-10V dimming with appropriate drivers Other options (consult factory): TRIAC/MLV, DMX, DALI, Casambi, Power over Ethernet

Luminaire Construction

LED Light Source	W22S = CCT: 2200K, CRI (Ra): 80+, Colour Consistency: 3SDCM W27H = CCT: 2700K, CRI (Ra): 90+, Colour Consistency: 2SDCM W30H = CCT: 3000K, CRI (Ra): 90+, Colour Consistency: 2SDCM W35H = CCT: 3500K, CRI (Ra): 90+, Colour Consistency: 3SDCM (Contact factory for 2SDCM option) W41H = CCT: 4100K, CRI (Ra): 90+, Colour Consistency: 3SDCM
Standard Compliance	✓ADA-compliant ✓WELL standard – Feature 58: Color Quality
Weight	0.78lbs (0.35kg)
Material	Fixture: machined marine-grade aluminum
Supplied with	Standard installation housing: Comes with LED unit with coverplate, mounting bracket, cross countersunk screws(2), wire nuts(2), M3 set screw, and 2.5mm allen key. Driver: Non-dimmable integral driver included.
Warranty & LED Life	5 years limited warranty Estimated useful life of LED is 50,000 hours.

Ordered Separately

System Components	Power supplies: alternate remote driver for dimming options Please consult factory or visit Recommended Drivers for available driver options. Mounting kit: MK1 & Back box Custom rectangular back boxes: see Pg.3- Mounting Options & Dimensions.
-------------------	--

Mounting Options & Dimensions

LED Insert Dimensions | Vertical

Fixture
Top & Front View

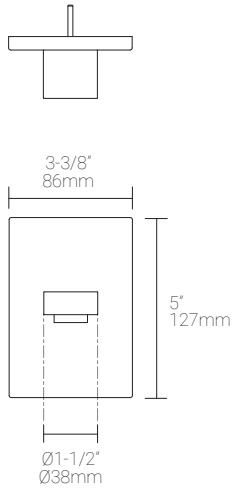

Side View

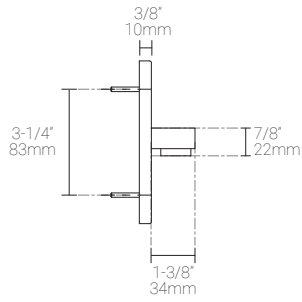

3D View



Beam

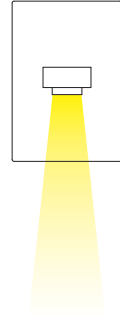

LED Insert Dimensions | Horizontal

Fixture
Top & Front View

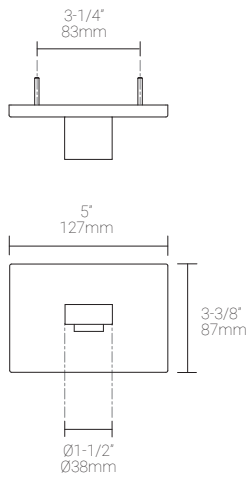

Side View

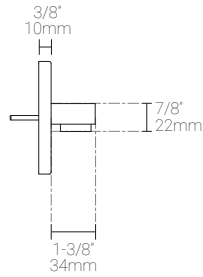

3D View



Beam

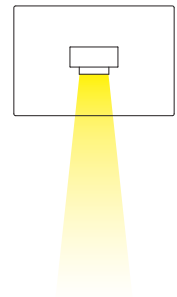

Fixture with 120° beam option

Fixture Front View - vertical

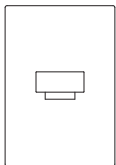

Fixture Front View - horizontal

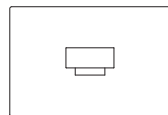

Custom Rectangular Back Box for Wall Installation

MP Lighting Single Gang Back Box | Order Code: EBX-SGB1

Top View

Side View

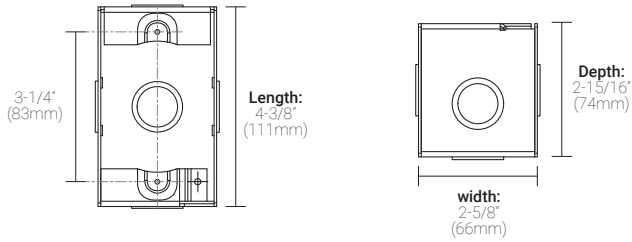

Scepter FD Back box | Order Code: EBX-SFD

Top View

Side View

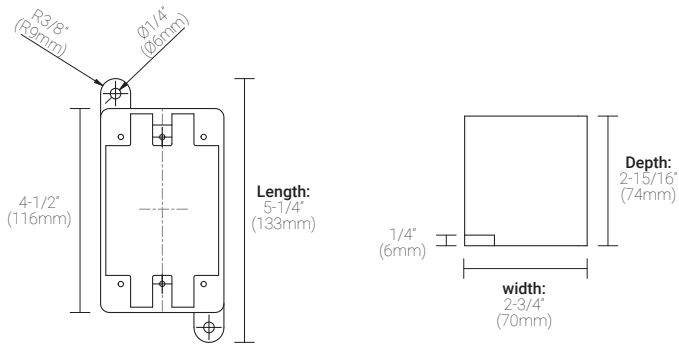

MK1 | For walls and stairs

Mounting Kit Exploding Views * Back box not included

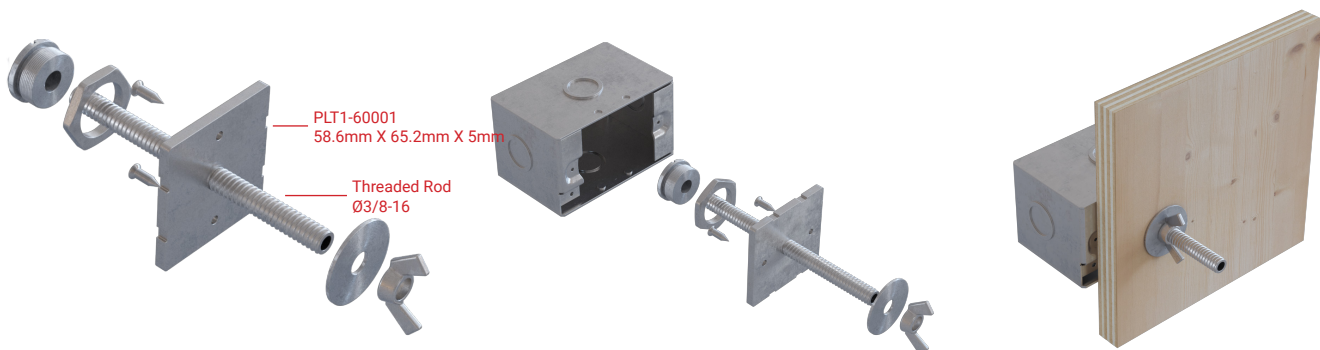

MK1-SGB1

MK1-SGB1 shown with EBX-SGB1

MK1-SGB1 shown with EBX-SGB1 and Plywood Form

1W, 3000K, 90+ CRI

Polar Candela Distribution

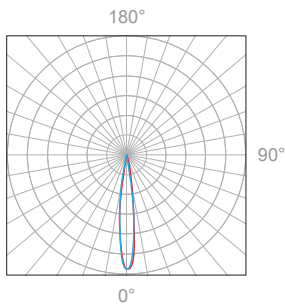

Beam Width: 12°



Illuminance at a Distance | Mounting Height: 1' (0.3m)

Distance		Center Beam fc	Beam Width			
1.0ft	0.30m	542fc	0.3ft	0.09m	0.3ft	0.09m
2.0ft	0.61m	135fc	0.7ft	0.21m	0.7ft	0.21m
3.0ft	0.91m	60.2fc	1.0ft	0.30m	1.0ft	0.30m
4.0ft	1.22m	33.9fc	1.4ft	0.42m	1.4ft	0.42m
5.0ft	1.52m	21.7fc	1.7ft	0.51m	1.7ft	0.51m
6.0ft	1.82m	15.1fc	2.0ft	0.61m	2.0ft	0.61m

Delivered Lumen: 89.6 lm

- Vertical Beam Spread : 19.3°
- Horizontal Beam Spread : 19.2°

Polar Candela Distribution

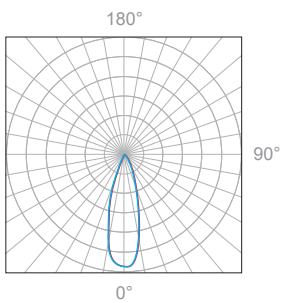

Beam Width: 30°

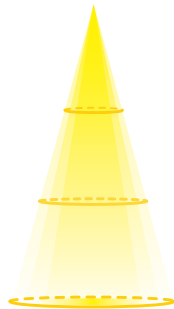

Illuminance at a Distance | Mounting Height: 1' (0.3m)

Distance		Center Beam fc	Beam Width			
1.0ft	0.30m	352fc	0.5ft	0.15m	0.4ft	0.12m
2.0ft	0.61m	88.0fc	1.0ft	0.30m	0.9ft	0.27m
3.0ft	0.91m	39.1fc	1.4ft	0.42m	1.3ft	0.39m
4.0ft	1.22m	22.0fc	1.9ft	0.58m	1.8ft	0.55m
5.0ft	1.52m	14.1fc	2.4ft	0.72m	2.2ft	0.67m
6.0ft	1.82m	9.78fc	2.9ft	0.88m	2.7ft	0.82m

Delivered Lumen: 89.9 lm

- Vertical Beam Spread : 26.7°
- Horizontal Beam Spread : 25.3°

Polar Candela Distribution

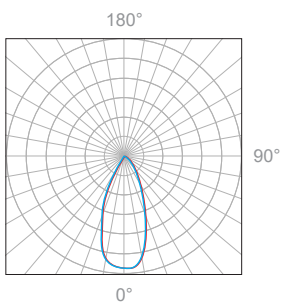

Beam Width: 45°

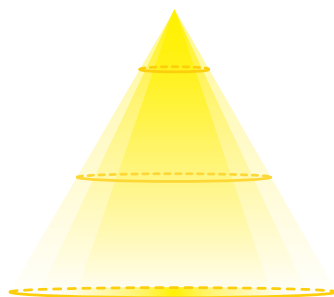

Illuminance at a Distance | Mounting Height: 1' (0.3m)

Distance		Center Beam fc	Beam Width			
1.0ft	0.30m	125fc	0.9ft	0.27m	0.8ft	0.24m
2.0ft	0.61m	31.4fc	1.7ft	0.51m	1.6ft	0.48m
3.0ft	0.91m	13.9fc	2.6ft	0.79m	2.4ft	0.72m
4.0ft	1.22m	7.84fc	3.4ft	1.03m	3.3ft	1.00m
5.0ft	1.52m	5.02fc	4.3ft	1.31m	4.1ft	1.25m
6.0ft	1.82m	3.48fc	5.1ft	1.55m	4.9ft	1.49m

Delivered Lumen: 84.9 lm

- Vertical Beam Spread : 46.3°
- Horizontal Beam Spread : 44.3°

Polar Candela Distribution

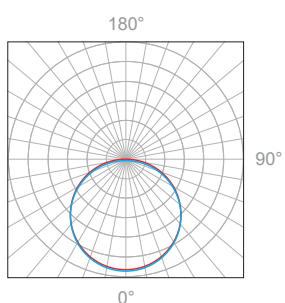

Beam Width: 120°

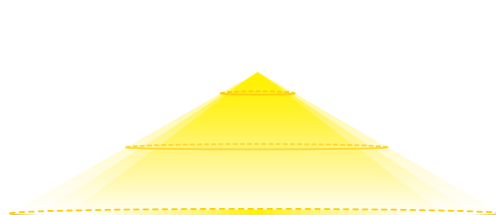

Illuminance at a Distance | Mounting Height: 1' (0.3m)

Distance		Center Beam fc	Beam Width			
1.0ft	0.30m	33.8fc	0.8ft	0.24m	1.6ft	0.48m
2.0ft	0.61m	8.44fc	1.5ft	0.45m	3.2ft	0.97m
3.0ft	0.91m	3.75fc	2.3ft	0.70m	4.9ft	1.49m
4.0ft	1.22m	2.11fc	3.1ft	0.94m	6.5ft	1.98m
5.0ft	1.52m	1.35fc	3.8ft	1.15m	8.1ft	2.46m
6.0ft	1.82m	0.94fc	4.6ft	1.40m	9.7ft	2.95m

Delivered Lumen: 71.9 lm

- Vertical Beam Spread : 41.8°
- Horizontal Beam Spread : 78.0°

2W, 3000K, 90+ CRI

Polar Candela Distribution

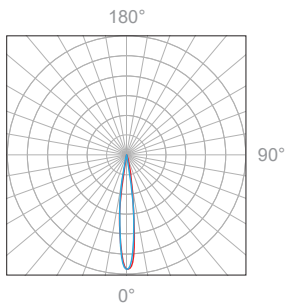

Beam Width: 12°



Illuminance at a Distance | Mounting Height: 1' (0.3m)

Distance		Center Beam fc	Beam Width			
1.0ft	0.30m	984fc	0.3ft	0.09m	0.3ft	0.09m
2.0ft	0.61m	246fc	0.7ft	0.21m	0.7ft	0.21m
3.0ft	0.91m	109fc	1.0ft	0.30m	1.0ft	0.30m
4.0ft	1.22m	61.5fc	1.4ft	0.42m	1.4ft	0.42m
5.0ft	1.52m	39.4fc	1.7ft	0.51m	1.7ft	0.51m
6.0ft	1.82m	27.3fc	2.0ft	0.61m	2.0ft	0.61m

Delivered Lumen: 162.8 lm

Vertical Beam Spread : 19.2°

Horizontal Beam Spread : 19.2°

Polar Candela Distribution

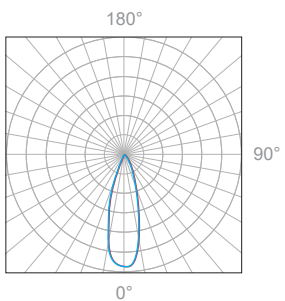

Beam Width: 30°

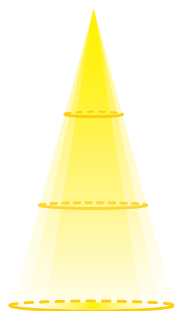

Illuminance at a Distance | Mounting Height: 1' (0.3m)

Distance		Center Beam fc	Beam Width			
1.0ft	0.30m	352fc	0.5ft	0.15m	0.4ft	0.12m
2.0ft	0.61m	88.0fc	0.9ft	0.27m	0.9ft	0.27m
3.0ft	0.91m	39.1fc	1.4ft	0.42m	1.3ft	0.39m
4.0ft	1.22m	22.0fc	1.9ft	0.58m	1.8ft	0.55m
5.0ft	1.52m	14.1fc	2.4ft	0.72m	2.2ft	0.67m
6.0ft	1.82m	9.78fc	2.8ft	0.85m	2.7ft	0.82m

Delivered Lumen: 163.3 lm

Vertical Beam Spread : 26.7°

Horizontal Beam Spread : 25.2°

Polar Candela Distribution

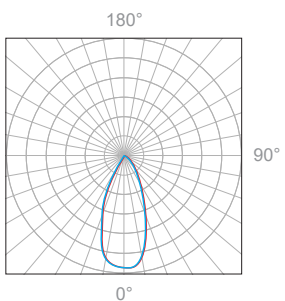

Beam Width: 45°

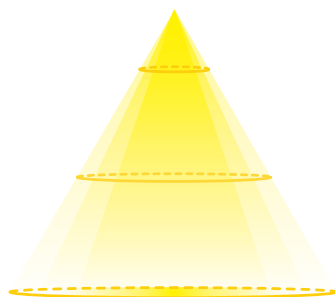

Illuminance at a Distance | Mounting Height: 1' (0.3m)

Distance		Center Beam fc	Beam Width			
1.0ft	0.30m	228fc	0.9ft	0.27m	0.8ft	0.24m
2.0ft	0.61m	57.1fc	1.7ft	0.51m	1.6ft	0.48m
3.0ft	0.91m	25.4fc	2.6ft	0.79m	2.4ft	0.72m
4.0ft	1.22m	14.3fc	3.5ft	1.06m	3.3ft	1.00m
5.0ft	1.52m	9.13fc	4.3ft	1.31m	4.1ft	1.25m
6.0ft	1.82m	6.34fc	5.2ft	1.58m	4.9ft	1.49m

Delivered Lumen: 153.6 lm

Vertical Beam Spread : 46.7°

Horizontal Beam Spread : 44.4°

Polar Candela Distribution

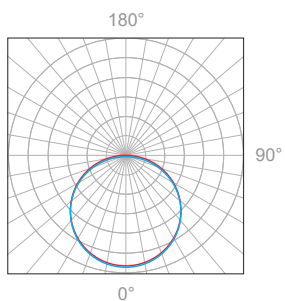

Beam Width: 120°

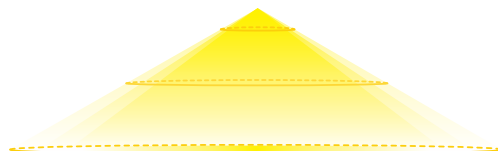

Illuminance at a Distance | Mounting Height: 1' (0.3m)

Distance		Center Beam fc	Beam Width			
1.0ft	0.30m	61.1fc	0.8ft	0.24m	1.6ft	0.48m
2.0ft	0.61m	15.3fc	1.5ft	0.45m	3.2ft	0.97m
3.0ft	0.91m	6.79fc	2.3ft	0.70m	4.8ft	1.46m
4.0ft	1.22m	3.82fc	3.0ft	0.91m	6.5ft	1.98m
5.0ft	1.52m	2.44fc	3.8ft	1.15m	8.1ft	2.46m
6.0ft	1.82m	1.70fc	4.5ft	1.37m	9.7ft	2.95m

Delivered Lumen: 130 lm

Vertical Beam Spread : 41.1°

Horizontal Beam Spread : 77.9°