

L72SF24

Installation Instructions

LED72 Single Rail Wall Flush/24V

- 1** Unscrew screw on top of connector then separate connector.
- 2** Place both halves of connector on rail in desired location and retighten screw.
- 3** Once connector is securely fastened push in jack connector on fixture and thread cap until secure.

**for details see SF system overview or SF connector instructions.*

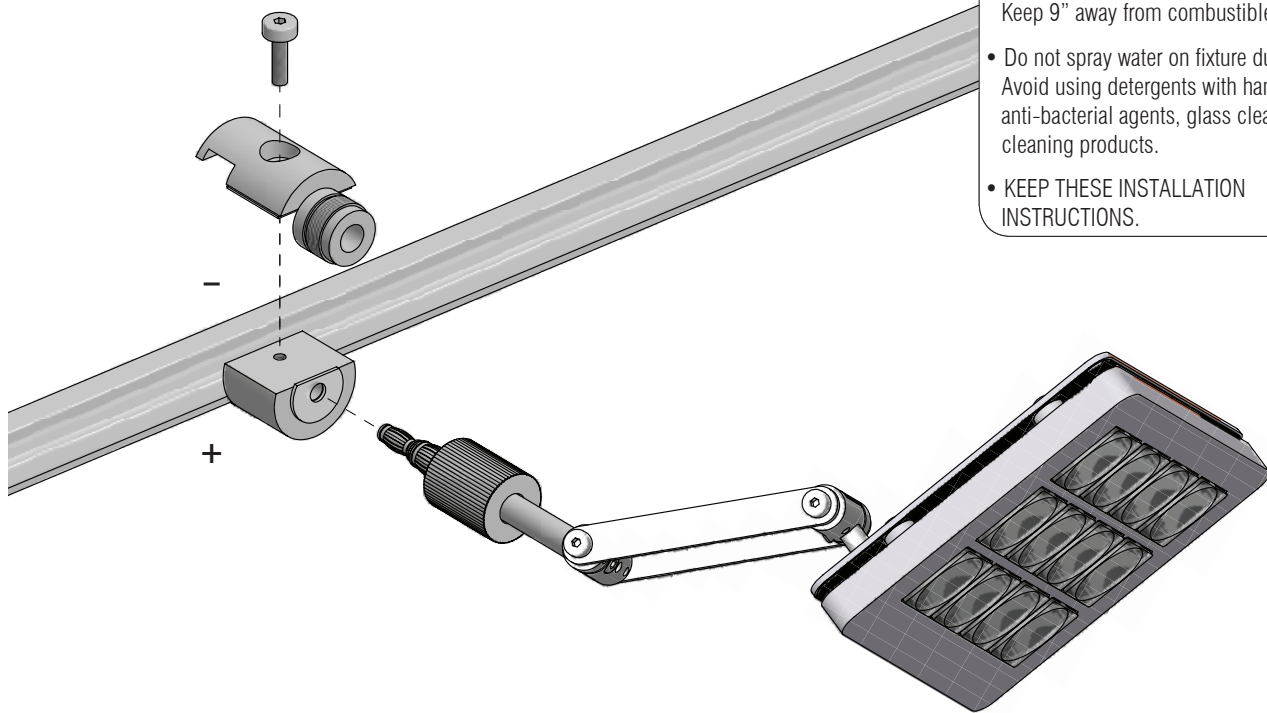

! CAUTION

- Read all instructions.
- **WARNING: RISK OF FIRE OR ELECTRICAL SHOCK:** Do not make or alter any openings in the compartment of wiring or electrical components during installation. Do not alter or add ballasts, or any other electrical components.
- Installation and use of this fixture mounting assembly requires a person familiar with the construction and operation of luminaire electrical systems and the hazards involved, if not qualified, do not attempt installation.
- Turn off power before installation.
- Do not move fixture along rail if power is on.
- Ensure cap is tight to prevent short circuit from occurring.
- Fixture gets very hot. Do not cover. Keep 9" away from combustible materials.
- Do not spray water on fixture during cleaning. Avoid using detergents with hand softeners, anti-bacterial agents, glass cleaners or acrylic cleaning products.
- **KEEP THESE INSTALLATION INSTRUCTIONS.**

Maintenance

Clean using a soft cloth.

[✓] MP LIGHTING

T 604 708 1184 mplighting.com