

L740

EXTERIOR | INTERIOR

Steplight | For walls, stairs, and walkways.

- Wet, Damp, and Dry location



Ordering Information

Clear Form

Date : _____

Quantity : _____

Project : _____

Note : _____

Type : _____

Specifications

Luminaire | Example Code: L740-3-W30H-MK1-MA

Product	Version	CCT & CRI ¹	Mounting Kit ² (optional)	Finish ³
L740	3 3W 6 6W	W22S 2200K 80+ W27H 2700K 90+ W30H 3000K 90+ W35H 3500K 90+ W41H 4100K 90+	MK1 vertical surface	Aluminum Finishes: MA matte clear anodized BK black powder coated WH white powder coated BZ bronze powder coated

System Components (Ordered Separately)

Remote Driver : _____

* Consult MP Lighting Website or Factory.

Important Notes

Specifications

- Refer to pg.2 - for Light quality and colour consistency details.
- Mounting kit is ordered separately (consult factory). Back box must also be purchased with MK1 kit.
- Refer to Appendix or MP Lighting website for complete look of luminaire with different finish options.

Warranty Notes & Disclaimer

Malfunction and damage to product due to incompatible dimming system or misuse will not be covered under warranty. Consult MP Lighting for recommended drivers. If the fixture has an option to be installed with a dimming control system, consult a dimming system manufacturer with minimum load before installing. MP Lighting reserves the right, at its sole discretion, at any time and without notice, to make design changes to any of our products. Consult MP Lighting website for most updated documentation.

L740

EXTERIOR | INTERIOR

Steplight | For walls, stairs, and walkways.

- Wet, Damp, and Dry location



Performance

Wattage	Forward Current	Power Consumption Budget per fixture (including driver)	LED output (Source)	Fixture Output (Delivered)
3W	350mA	4W	330 lm	35 lm
6W	700mA	8W	660 lm	56 lm

Application

Environment	Dry / Damp / Wet Location approved. IP 66.
Mounting	Mounts to single gang box (ordered separately) or octagonal back box (ordered separately). Box opening: Width 2-3/8" (60.33mm) X Height 2" (50.8mm) MK1 mounting kit (optional): Recommended for easy installation on vertical surfaces (e.g. stair risers, walls). See "Mounting Options & Dimensions, " or visit MK1

Electrical

Power Supplies	Non-dimmable integral driver included (100-240V AC input). Compatible with remote driver for wet locations (not included).
Control	On/off control Dimming(consult factory): ELV or 0-10V dimming with appropriate drivers Other options (consult factory): TRIAC/MLV, DMX, DALI, Casambi, Power over Ethernet

Luminaire Construction

LED Light Source	W22S = CCT: 2200K, CRI (Ra): 80+, Colour Consistency: 3SDCM W27H = CCT: 2700K, CRI (Ra): 90+, Colour Consistency: 2SDCM W30H = CCT: 3000K, CRI (Ra): 90+, Colour Consistency: 2SDCM W35H = CCT: 3500K, CRI (Ra): 90+, Colour Consistency: 3SDCM (Contact factory for 2SDCM option) W41H = CCT: 4100K, CRI (Ra): 90+, Colour Consistency: 3SDCM
Standard Compliance	✓ADA-compliant ✓WELL standard – Feature 58: Color Quality
Weight	1.5 lbs (0.68 kg). Typical Aluminum Fixture.
Material	Fixture: machined marine-grade aluminum with tempered glass
Supplied with	Driver: Non-dimmable integral driver included.
Warranty & LED Life	5 years limited warranty Estimated useful life of LED is 50,000 hours.

Ordered Separately

System Components	Power supplies: alternate remote driver for dimming options Please consult factory or visit Recommended Drivers for available driver options. Mounting kit: MK1 & Back box Custom back boxes: see Pg.3- Mounting Options & Dimensions.
-------------------	--

Mounting Options & Dimensions

LED Insert Dimensions

Fixture

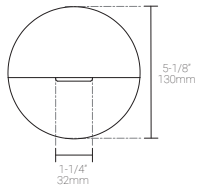

Side View

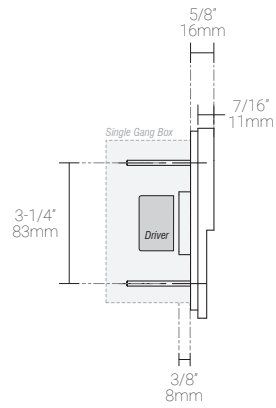

3D View



Beam

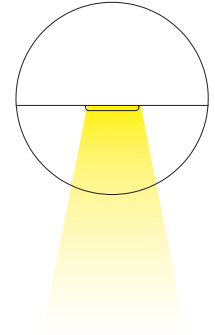

Custom Rectangular Back Box for Wall Installation

MP Lighting Single Gang Back Box | Order Code: EBX-SGB1

Top View

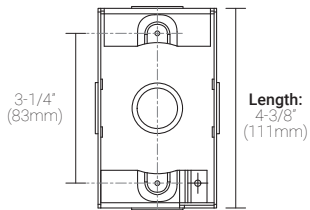

Side View

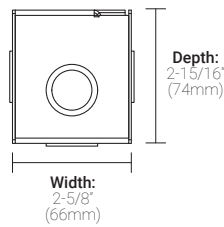

Scepter FD Back box | Order Code: EBX-SFD

Top View

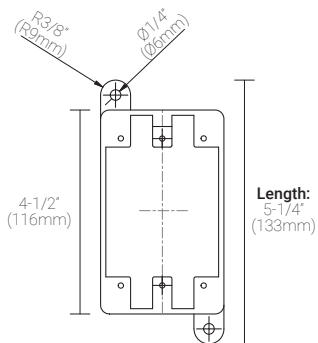

Side View

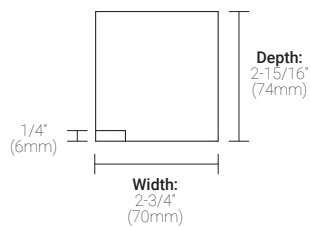

MK1 | For walls and stairs

Mounting Kit Exploding Views * Back box not included

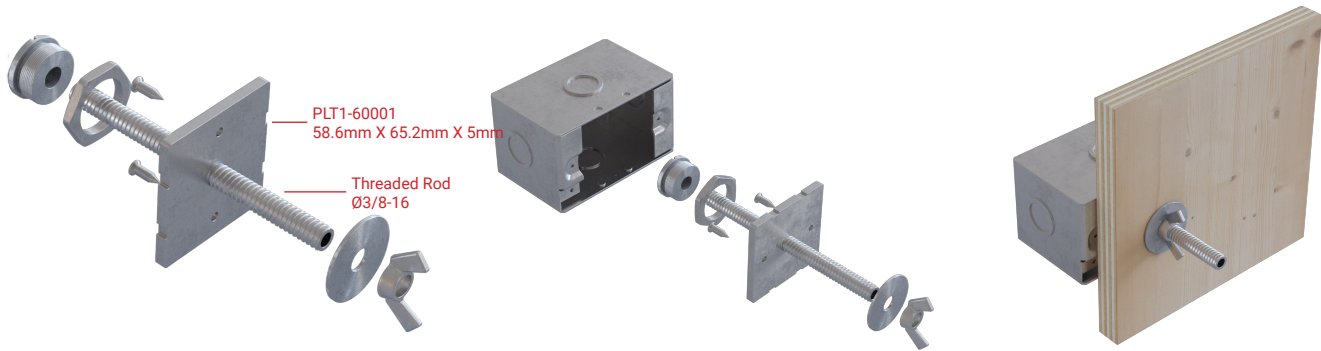

MK1-SGB1

MK1-SGB1 shown with EBX-SGB1

MK1-SGB1 shown with EBX-SGB1 and Plywood Form

3W, 3000K, 90+ CRI

Polar Candela Distribution

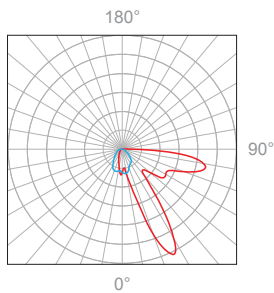

Isofootcandle Plot

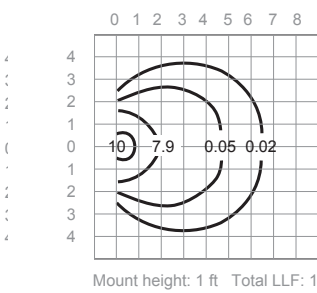

Illuminance at a Distance

Distance		Center Beam fc	Beam Width			
0ft	0m	10fc	2.9ft	0.88m	0.5ft	0.15m
2.0ft	0.61m	7.9fc	5.8ft	1.77m	1.0ft	0.30m
5.0ft	1.52m	0.05fc	8.7ft	2.65m	1.5ft	0.46m
7.0ft	2.13m	0.02fc	11.7ft	3.57m	2.0ft	0.60m

Delivered Lumens: 35lm
 ■ Vertical Beam Spread: 15.4°
 ■ Horizontal Beam Spread: 76.2°

6W, 3000K, 90+ CRI

Polar Candela Distribution

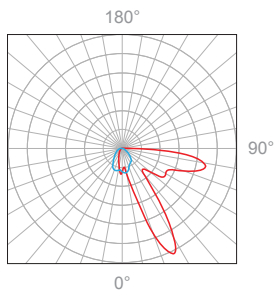

Isofootcandle Plot

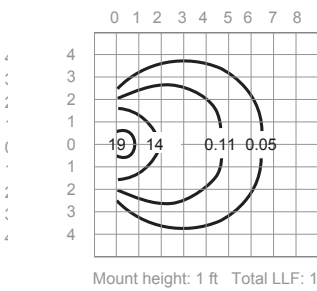

Illuminance at a Distance

Distance		Center Beam fc	Beam Width			
0ft	0m	19fc	2.9ft	0.88m	0.5ft	0.15m
2.0ft	0.61m	14fc	5.8ft	1.77m	1.0ft	0.30m
5.0ft	1.52m	0.11fc	8.7ft	2.65m	1.5ft	0.46m
7.0ft	2.13m	0.05fc	11.7ft	3.57m	2.0ft	0.60m

Delivered Lumens: 56lm
 ■ Vertical Beam Spread: 15.4°
 ■ Horizontal Beam Spread: 76.1°

Appendix

Aluminum Finishes



MA matte clear anodized



BK black powder coated



BZ bronze powder coated



WH white powder coated