

L802-U-i109

Suspended Linear LED

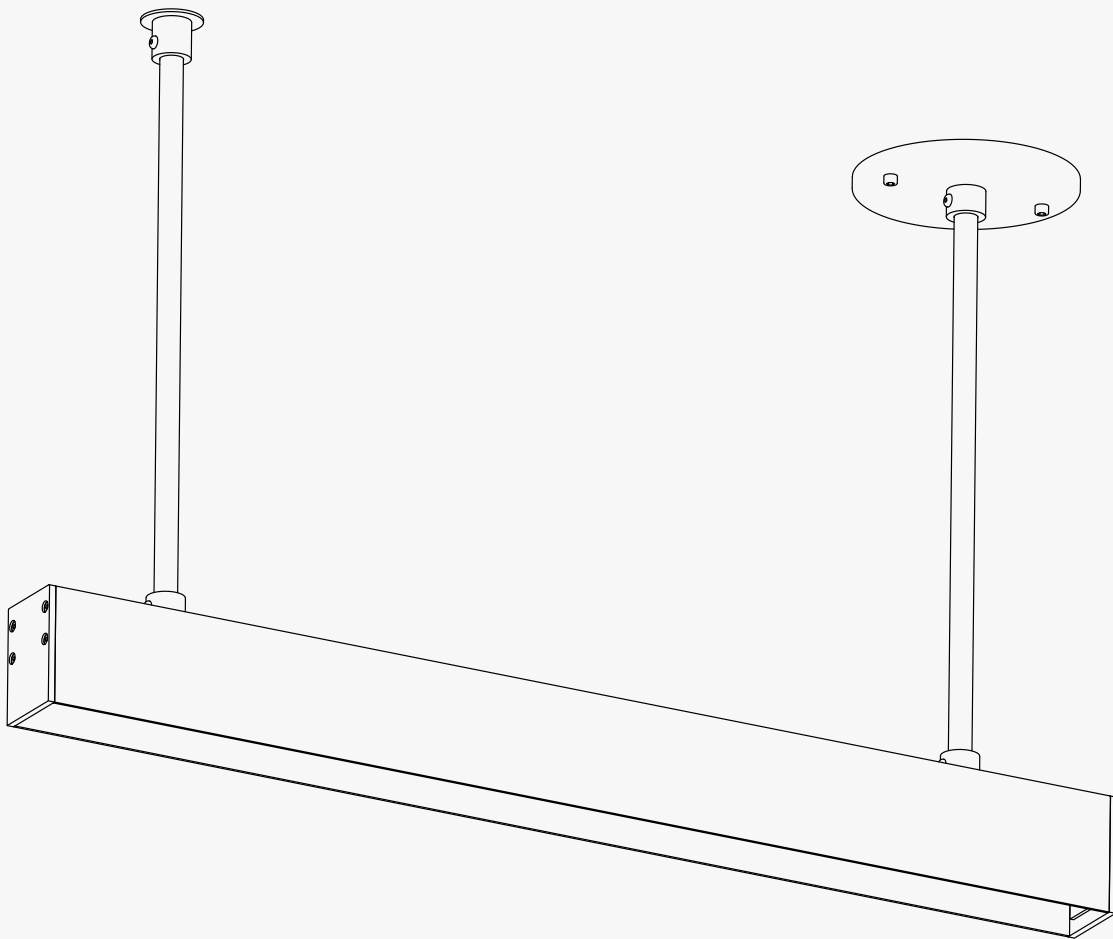

L802-U-i109

Fixture Suspension Assembly

Parts

LED fixture housing
SDF081 Rod Suspension Stand-off
CPY061 Rod Suspension Power Canopy
Mounting Screws

*It is recommended to assemble fixture with stems on a flat surface before mounting it to ceiling.

*Turn off power prior to installation.

- 1) Feed wires from fixture through stem into power canopy.
- 2) Secure stems to fixture on lower stand-offs. Position of the lower stand-off is factory mounted to fixture. It is not recommended to readjust. For details, refer to *Power Canopy* and *Stand-off assembly* on following pages.
- 3) Mount canopy to power canopy stem. Refer to *Power Canopy assembly*.
- 4) Mount upper stand-off to ceiling. Ensure it is aligned with the fixture. Refer to *Stand-off assembly*.
- 5) Raise assembled fixture and power canopy to the ceiling. Connect to remote driver.
- 5) Secure power canopy to ceiling, and upper stem to stand-off. Refer to *Stand-off assembly*.

**Ensure fixture is level and supported on either sides during completion of final steps.

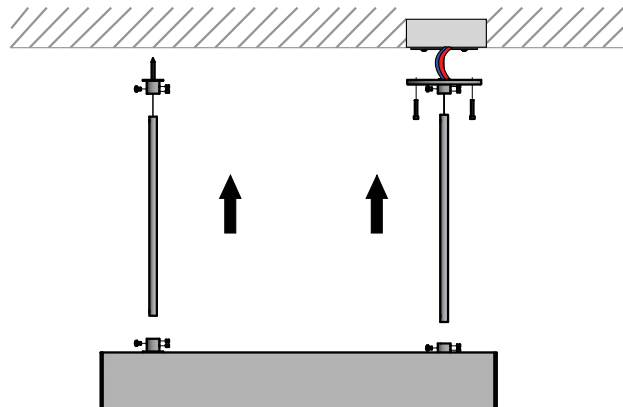
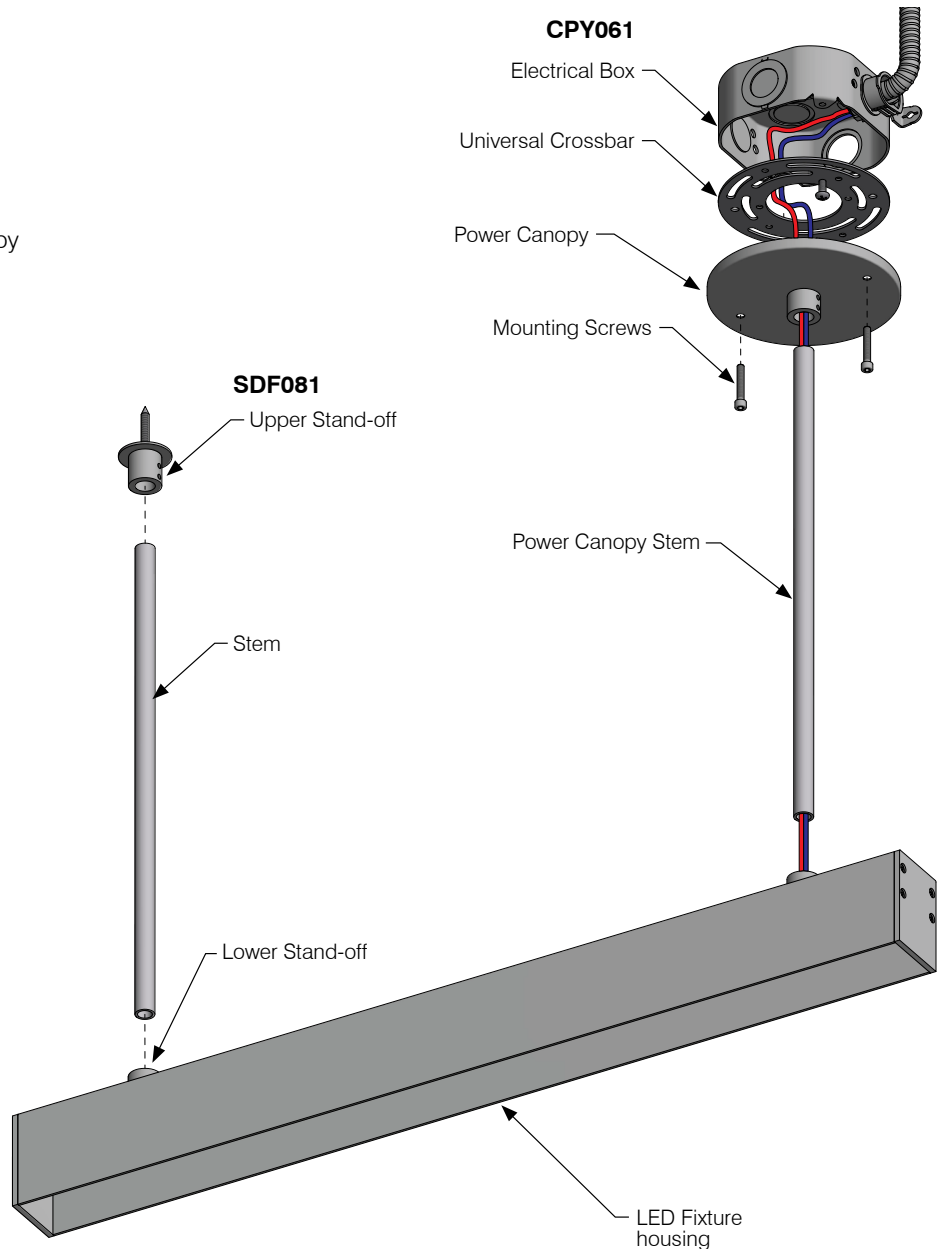

L802-U-i109

Power Canopy Assembly

Parts

CPY061 Rod Suspension Power
Allen Key
Set Screws
Locking Screw
Mounting Screws

1) Insert bottom of stem into lower stand-off. Ensure orientation of locking screw hole aligns with stem hole. Secure in place using two set screws and locking screw

2) Insert top of stem into canopy. Secure in place using two set screws and locking screw.

*Ensure upper and lower stand-offs are properly aligned before mounting to ceiling.

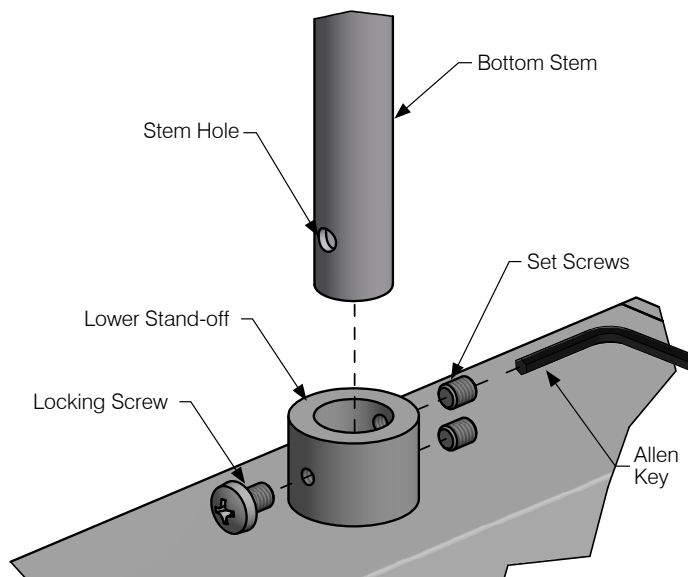
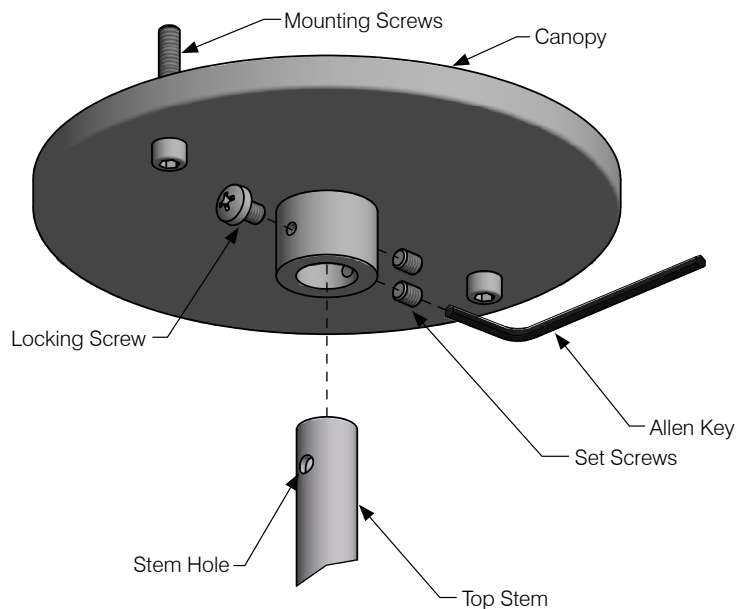

L802-U-i109

Stand-off Assembly

Parts

SDF081 Rod Suspension Stand-off
Allen Key
Set Screws
Locking Screw
Mounting Screw
Mounting Screw (*not provided*)

1) When inserting the bottom stem into the lower stand-off, ensure orientation of locking screw hole aligns with stem hole. Secure in place using two set screws and locking screw.

2) Mount stand-off to ceiling using mounting screw.

*To ensure proper support, it is recommended to use a wall anchor when mounting to drywall or sheet rock.

**Ensure *power canopy assembly* has been completed before completing the next step.

3) When inserting top of stem into stand-off, ensure orientation of locking screw hole aligns with stem hole. Secure in place using two set screws and locking screw.

***Ensure upper and lower stand-offs are properly aligned before mounting to ceiling.

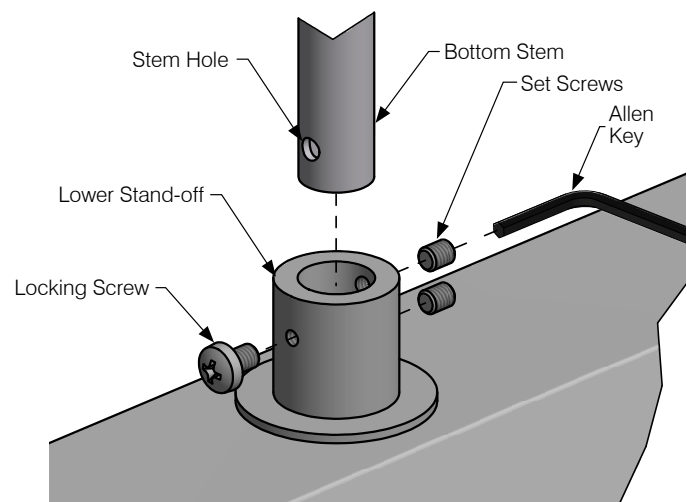
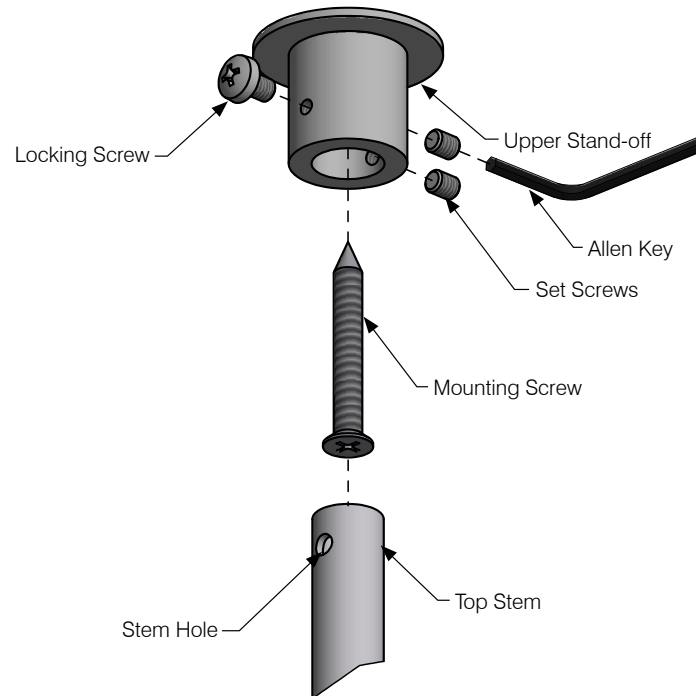

L802-U-i109

Fixture Assembly Diagram with LED Downlight

Parts

LED fixture housing
2 x End Caps
LED rail
Magnets

1) Push LED rail into fixture housing until magnets hold in place. Ensure the LED rail is secure.

*Removal of endcaps is not required to install fixture. However, if endcaps need to be removed, unscrew the 4 screws from the screw-ports on the end of the fixture housing.

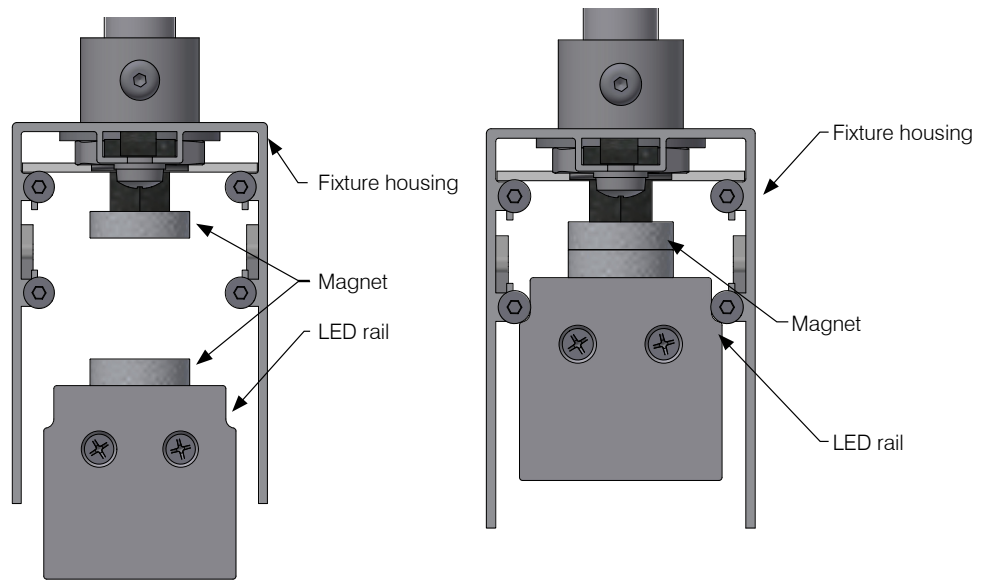

PUSH

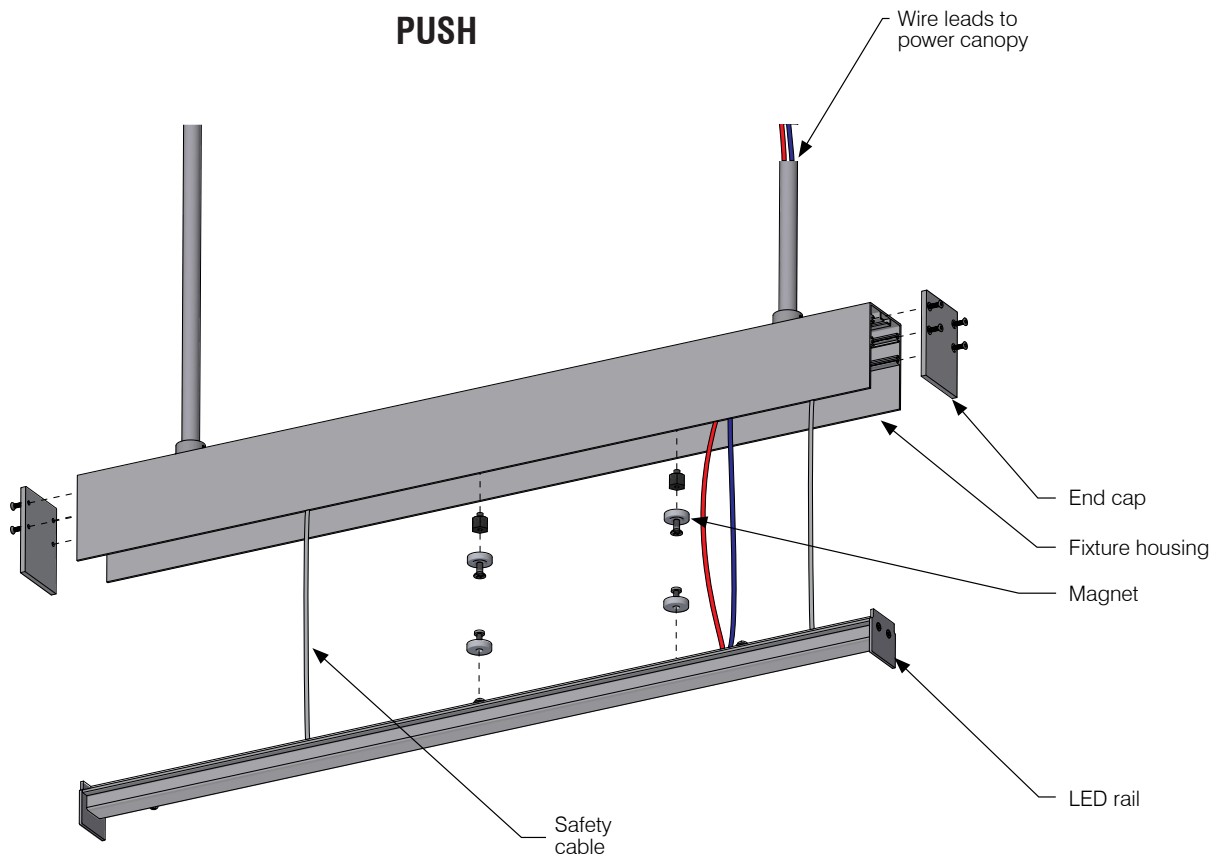

IMPORTANT SAFETY INSTRUCTIONS

KEEP THESE INSTALLATION INSTRUCTIONS

(Including General and Additional Markings for Fixtures)

(FOR MP LIGHTING LED LUMINAIRES, CLASS 3402-xx)

General and additional markings

1. For Use Only with Certified/NRTL Driver, Model _____
2. DRY LOCATIONS ONLY or OUTDOOR USE ONLY or DRY/
OUTDOOR USE ONLY or Outdoor / submersible Use Only - as
indicated on fixtures
3. MIN 90 C SUPPLY CONDUCTORS
4. Models L01, L03, L04, L05, L06, and L07: SUITABLE FOR USE IN
POURED CONCRETE, USE ON CLASS 2 CIRCUIT ONLY

Installation instructions

1. The grounding installation shall be done in accordance with
CEC-Part 1.
2. WARNING: RISK OF FIRE OR ELECTRIC SHOCK: DO NOT
MAKE OR ALTER ANY OPENINGS IN THE COMPARTMENT
OF WIRING OR ELECTRICAL COMPONENTS DURING
INSTALLATION. DO NOT ALTER OR ADD BALLASTS, OR ANY
OTHER ELECTRICAL COMPONENTS.
3. INSTALLATION AND USE OF THIS FIXTURE MOUNTING
ASSEMBLY REQUIRES A PERSON FAMILIAR WITH THE
CONSTRUCTION AND OPERATION OF LUMINAIRE
ELECTRICAL SYSTEMS AND THE HAZARD INVOLVED, IF NOT
QUALIFIED, DO NOT ATTEMPT INSTALLATION. CONTACT A
QUALIFIED ELECTRICIAN.
4. TURN OFF POWER BEFORE INSTALLATION.
5. KEEP THESE INSTALLATION INSTRUCTIONS.

CONSIGNES DE SÉCURITÉ IMPORTANTES

CONSERVER CES INSTRUCTIONS D'INSTALLATION

(Dont le général et marques supplémentaires pour les appareils)

(Pour les luminaires LED MP D'ÉCLAIRAGE , CLASS 3402 -xx)

Général et marquages supplémentaires

1. A utiliser uniquement avec Certified / NRTL pilote, modèle _____
2. POUR EMPLACEMENTS SECS SEULEMENT ou UTILISATION
EXTÉRIEURE SEULEMENT ou SEC / UTILISATION EXTÉRIEURE
SEULEMENT ou extérieure / Utilisation submersible seulement -
comme indiqué sur les appareils
3. LES FILS D'ALIMENTATION 90 °C MIN
4. Modèles L01, L03, L04, L05, L06, L07 et: utilisables dans le béton
coulé, UTILISATION DE CLASSE 2 CIRCUIT UNIQUEMENT

Les instructions d'installation

1. L'installation de mise à la terre doit être fait en conformité avec
CEC Partie 1.
2. AVERTISSEMENT : RISQUE D'INCENDIE OU
D'ÉLECTROCUTION : NE PAS FAIRE OU MODIFIER DES
OUVERTURES DANS LE COMPARTIMENT DE CÂBLAGE OU
DE COMPOSANTS ÉLECTRIQUES LORS DE L'INSTALLATION.
NE PAS MODIFIER OU AJOUTER DES BALLASTS, OU AUTRES
COMPOSANTS ÉLECTRIQUES
3. CE PRODUIT DOIT ÊTRE INSTALLÉ SELON LE CODE
D'INSTALLATION PERTINENT, PAR UNE PERSONNE QUI
CONNAÎT BIEN LE PRODUIT ET SON FONCTIONNEMENT
AINSI QUE LES RISQUES INHÉRENTS. CONSULTER UN
ÉLECTRICIEN QUALIFIÉ.
4. COUPER LE COURANT AVANT L'INSTALLATION.
5. CONSERVEZ CES INSTRUCTIONS.