

L800 series | L802-I109

INTERIOR

Linear | Linear beam series with different insert options

- Dry location

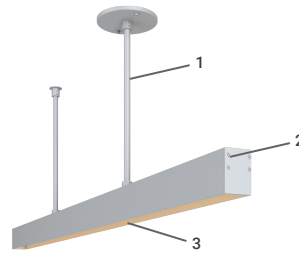

1 mounting | 2 linear profile | 3 insert (downlight)

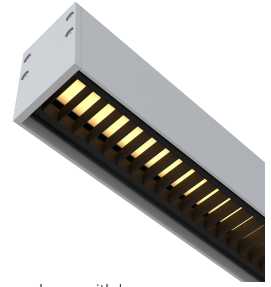

shown with louver

Ordering Information

Clear Form

Date : _____

Project : _____

Type : _____

Quantity : _____

Note : _____

Specifications

Fixture comprises of 3 components that need to be specified separately: Mounting (only suspended-mount needs specification), Rail, and Insert Luminaire

Example Code (Suspended): U-C12-BA // RAL-802-8-BA // I109-6-W35H-W-F | Example Code (Surface): RAL-802-8-BA // I109-6-W35H-W-F

MOUNTING: Suspended Surface

COMPONENT 1 – MOUNTING (SUSPENDED)

Mounting	Stem Length or Cable Length	Finish (mounting) ^{1,2}
U		
U suspended	S12 12" (305mm) SX custom ^{1,1} C12 12" (305mm) CX custom ^{1,1}	Aluminum Finishes: MA matte clear anodized BA black anodized

COMPONENT 2 – RAIL

Rail	Fixture Length ^{2,1}	Finish (rail) ^{2,3}
RAL-802		
	1 1' (min.) X custom ^{2,2} 8 8' (max.)	Aluminum Finishes: MA matte clear anodized BA black anodized

COMPONENT 3 – INSERT

Insert	Wattage	CCT & CRI	Beam Angle	Lens	Accessories (optional)
I109	6				
	6 6W/ft	Standard (80+) CRI: W22S 2200K 80+ High (90+) CRI: W27H 2700K 90+ W30H 3000K 90+ W35H 3500K 90+ W41H 4100K 90+	N narrow flood, 30° F flood, 54° W wide flood, 120°	F frosted P prismatic	LLB linear louver, black

Important Notes

Specification

- 1.1 Maximum: 6' (1829mm), 1' (305mm) increments.
- 1.2 Refer to Appendix/MP Lighting website for complete look of luminaire with different finish options.
- 2.1 Fixture length is the length of the fixture without the end caps (3mm each cap).
- 2.2 Maximum: 8' (2438mm), 1' (305mm) increments.
- 2.3 Refer to Appendix/MP Lighting website for complete look of luminaire with different finish options.

System Components (Ordered Separately)

Remote Driver : _____

* Consult MP Lighting Website or Factory.

Warranty Notes & Disclaimer

Malfunction and damage to product due to incompatible dimming system or misuse will not be covered under warranty. Consult MP Lighting for recommended drivers. If the fixture has an option to be installed with a dimming control system, consult a dimming system manufacturer with minimum load before installing. MP Lighting reserves the right, at its sole discretion, at any time and without notice, to make design changes to any of our products. Consult MP Lighting website for most updated documentation.

L800 series | L802-I109

INTERIOR

Linear | Linear beam series with different insert options

- Dry location

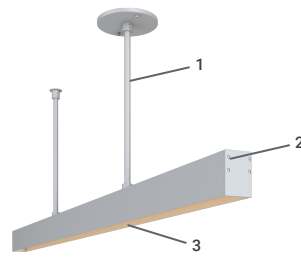

1 mounting | 2 linear profile | 3 insert (downlight)

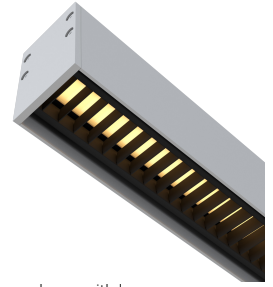

shown with louver

Performance

Insert	Wattage	Forward Current	Power Consumption Budget per fixture (including driver)	LED output (Source)	Fixture Output (Delivered)
I109	6W/ft	250mA	7W/ft	660 lm/ft	250 lm/ft

Application

Environment	Dry Location approved. IP 50.
Mounting	Surface-mounted: Mounts directly to surface or recessed mount with mounting screws (supplied by others). Suspension-mounted: Suspended from ceiling with a stand off and a canopy (both ordered separately).

Electrical

Power Supplies	Remote LED drivers: (120-277V AC input, constant voltage output): Fixtures to be wired in parallel. Recommended drivers (consult factory): TLDAV100W24V04iB or TLDAV100W24V05iB.
Control	Dimming: ELV or 0-10V dimming with appropriate drivers. Other options (consult factory): TRIAC/MLV, DMX, DALI, Casambi, Power over Ethernet.

Luminaire Construction

LED Light Source	W22S = CCT: 2200K, CRI (Ra): 80+, Colour Consistency: 3SDCM W27H = CCT: 2700K, CRI (Ra): 90+, Colour Consistency: 3SDCM W30H = CCT: 3000K, CRI (Ra): 90+, Colour Consistency: 3SDCM W35H = CCT: 3500K, CRI (Ra): 90+, Colour Consistency: 3SDCM W41H = CCT: 4100K, CRI (Ra): 90+, Colour Consistency: 3SDCM
Weight	N/A.
Material	Fixture: extruded marine-grade aluminum with polycarbonate lens.
Supplied with	Cable: 3' (914mm) factory-installed wire lead (for surface mount).
Warranty & LED Life	5 years limited warranty. Estimated useful life of LED is 50,000 hours.

Ordered Separately

System Components	Power supplies: remote driver Please consult factory or visit Recommended Drivers for available driver options.
-------------------	---

Mounting Options & Dimensions

LED Fixture Dimensions | Surface-mount

Fixture

Side View

3D View

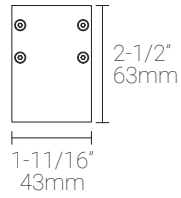

Side View

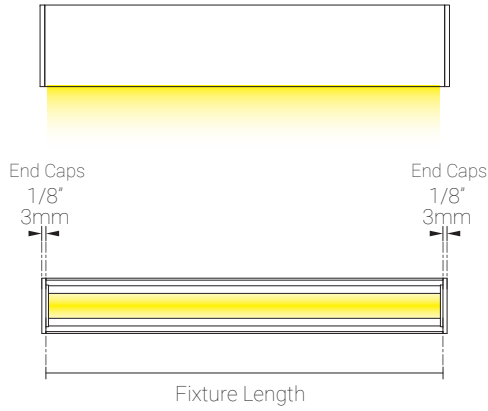

Surface-mount Installation

Fixture

Fixture installed - Side

Fixture installed - Front

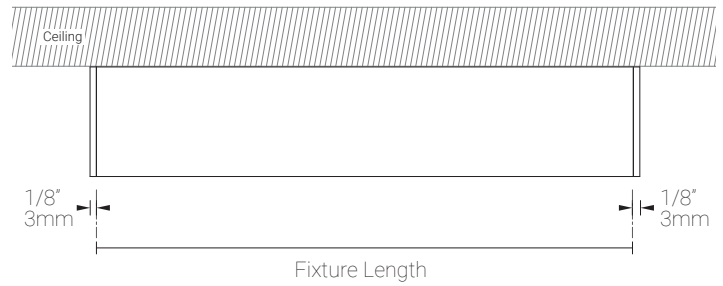
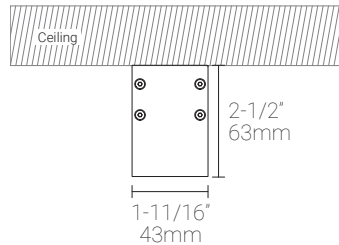
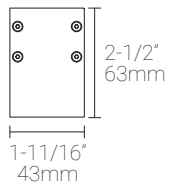

Suspended-mount Installation

Fixture

Mounting Dimensions

Fixture installed

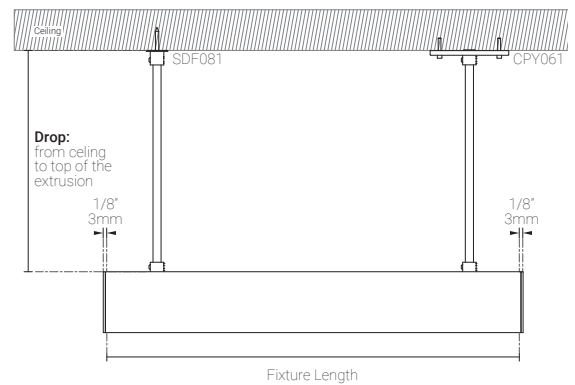
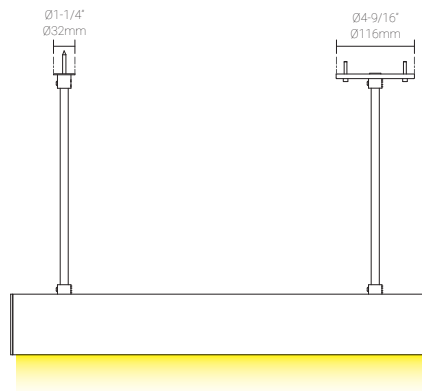
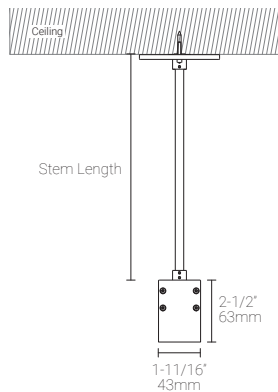

I109 6W/ft, 4' (1219mm), 2700K, 90+ CRI

Polar Candela Distribution

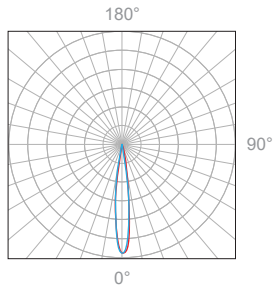

Beam Width: 30°

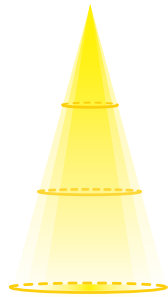

Illuminance at a Distance

Distance		Center Beam fc	Beam Width			
1.5ft	0.46m	446fc	1.9ft	0.58m	1.4ft	0.42m
3.0ft	0.91m	111fc	3.9ft	1.18m	2.8ft	0.85m
4.5ft	1.37m	49.5fc	5.8ft	1.76m	4.1ft	1.24m
6.0ft	1.83m	27.9fc	7.7ft	2.34m	5.5ft	1.67m
7.5ft	2.29m	17.8fc	9.7ft	2.95m	6.9ft	2.10m
9.0ft	2.74m	12.4fc	11.6ft	3.53m	8.3ft	2.53m

Delivered Lumen: 254.4 lm (1ft), 834.3 lm (1m), 1017.4 lm (4ft)

- Vertical Beam Spread : 65.6°
- Horizontal Beam Spread : 49.3°

Polar Candela Distribution

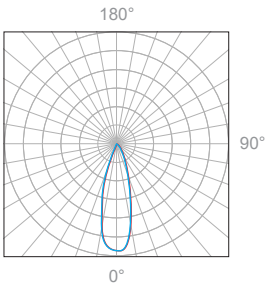

Beam Width: 54°

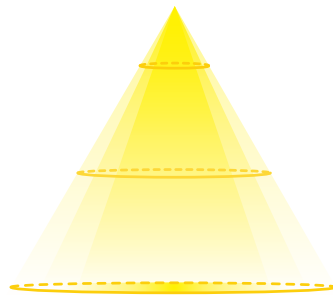

Illuminance at a Distance

Distance		Center Beam fc	Beam Width			
1.5ft	0.46m	400fc	2.3ft	0.70m	1.5ft	0.45m
3.0ft	0.91m	100fc	4.5ft	1.37m	2.9ft	0.88m
4.5ft	1.37m	44.5fc	6.8ft	2.07m	4.4ft	1.34m
6.0ft	1.83m	25.0fc	9.1ft	2.77m	5.9ft	1.79m
7.5ft	2.29m	16.0fc	11.4ft	3.47m	7.4ft	2.25m
9.0ft	2.74m	11.1fc	13.6ft	4.14m	8.8ft	2.68m

Delivered Lumen: 261.8 lm (1ft), 858.7 lm (1m), 1047.2 lm (4ft)

- Vertical Beam Spread : 74.3°
- Horizontal Beam Spread : 52.3°

Appendix

Aluminum Finishes, Mounts, and Accessories



MA matte clear anodized surface mounted



BA black anodized surface mounted



MA matte clear anodized suspension mounted



BA black anodized suspension mounted

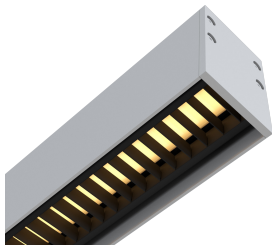

LLB linear louver, black

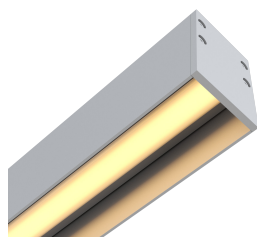

no louver