

M508

INTERIOR
Surface Mount Downlight

- Dry location



Shown with Spring Clips

Ordering Information

Clear Form

Date : _____

Quantity : _____

Project : _____

Note : _____

Type : _____

Specifications

Luminaire | Example Code: M508-1-W30H-N-BA

Product	Version	CCT & CRI ¹	Beam Angle	Finish ²
M508				
	1 1W	Standard (80+) CRI: W22S 2200K 80+	S spot 12° N narrow flood 30° F flood 45°	Aluminum Finishes: MA matte clear anodized BA black anodized
	2 2W			
		High (90+) CRI: W27H 2700K 90+ W30H 3000K 90+ W35H 3500K 90+ W41H 4100K 90+		

System Components (Ordered Separately)

Remote Driver : _____

* Consult MP Lighting Website or Factory.

Important Notes

Specification

1. Refer to pg.2 - for light quality and colour consistency details.
2. Refer to Appendix or MP Lighting website for complete look of luminaire with different finish options.

Warranty Notes & Disclaimer

Malfunction and damage to product due to incompatible dimming system or misuse will not be covered under warranty. Consult MP Lighting for recommended drivers. If the fixture has an option to be installed with a dimming control system, consult a dimming system manufacturer with minimum load before installing. MP Lighting reserves the right, at its sole discretion, at any time and without notice, to make design changes to any of our products. Consult MP Lighting website for most updated documentation.

M508

INTERIOR
Surface Mount Downlight

- Dry location



Shown with Spring Clips

Performance

Wattage	Forward Current	Power Consumption Budget per fixture (including driver)	LED output (Source)	Fixture Output (Delivered)
1W	350mA	1.5W	110 lm	73-83 lm
2W	700mA	3.0W	220 lm	144-152 lm

Application

Environment	Dry Location approved. IP 40.
Mounting	Recessed mount to cabinet millwork with friction fit spring clip. Comes with 2' (610mm) wire lead. Optimal spacing is 18" - 24"(457mm - 610mm).

Electrical

Electrical	Remote LED drivers (converter driver from constant voltage output to constant current output, 350mA to 700mA): Fixtures to be wired in series.
Control	On/off control Dimming: 0-10V dimming with appropriate driver Other options (consult factory): Casambi

Luminaire Construction

LED Light Source	W22S = CCT: 2200K, CRI (Ra): 80+, Colour Consistency: 3SDCM W27H = CCT: 2700K, CRI (Ra): 90+, Colour Consistency: 2SDCM W30H = CCT: 3000K, CRI (Ra): 90+, Colour Consistency: 2SDCM W35H = CCT: 3500K, CRI (Ra): 90+, Colour Consistency: 2SDCM W41H = CCT: 4100K, CRI (Ra): 90+, Colour Consistency: 3SDCM
Weight	0.07lbs (0.03kg)
Material	Fixture: Solid anodized aluminum.
Supplied with	Standard installation: Comes with universal crossbar and mounting screws (2), and driver. Optional: waterproof (IP 66) enclosure box with 1 or 2 cable glands, 1 vent, and aluminum plate.
Warranty & LED Life	5 years limited warranty. Estimated useful life of LED is 50,000 hours.

Ordered Separately

System Components	Enclosure box: remote driver Please consult factory or visit Recommended Drivers for available driver options. Please consult factory or visit Marine Enclosure Boxes for available enclosure box options.
-------------------	---

Mounting Options & Dimensions

LED Fixture Dimensions

Fixture

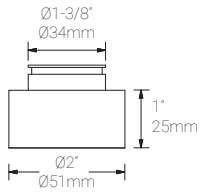

3D View

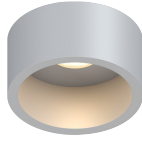

Beam

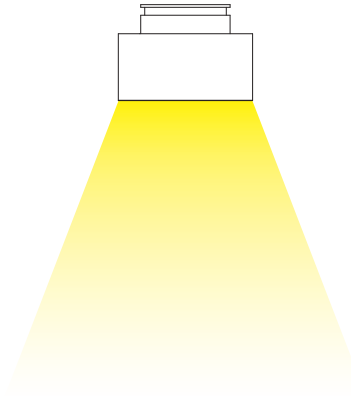

Fixture (shown with spring clips)

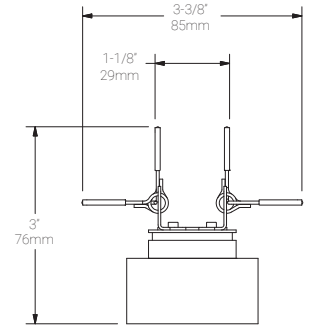

Bottom View

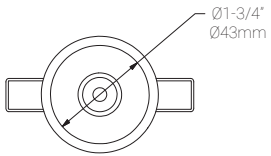

Installed

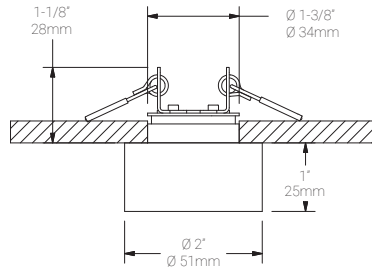

1W, 3000K, 90+ CRI, Silver Reflector

Polar Candela Distribution

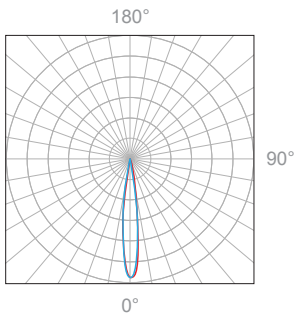

Beam Width: 12°



Illuminance at a Distance

Distance		Center Beam fc	Beam Width			
3.0ft	0.91m	52fc	0.8ft	0.24m	0.8ft	0.24m
6.0ft	1.83m	13fc	1.6ft	0.49m	1.6ft	0.49m
9.0ft	2.74m	5.9fc	2.3ft	0.70m	2.3ft	0.70m
12.0ft	3.66m	3.3fc	3.1ft	0.94m	3.1ft	0.94m
15.0ft	4.57m	2.1fc	3.9ft	1.19m	3.9ft	1.19m
18.0ft	5.49m	1.5fc	4.7ft	1.43m	4.7ft	1.43m

■ Vertical Beam Spread: 14.8°
 ■ Horizontal Beam Spread: 14.8°

Polar Candela Distribution

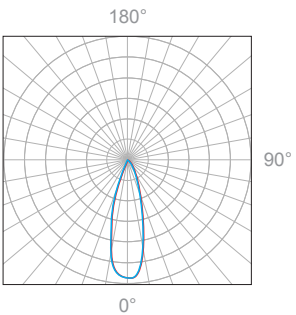

Beam Width: 30°

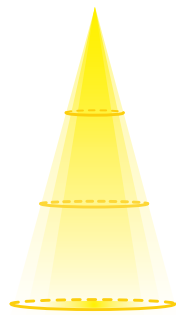

Illuminance at a Distance

Distance		Center Beam fc	Beam Width			
3.0ft	0.91m	43fc	1.7ft	0.52m	1.6ft	0.59m
6.0ft	1.83m	10fc	3.3ft	1.01m	3.3ft	1.01m
9.0ft	2.74m	4.8fc	5.0ft	1.52m	4.9ft	1.49m
12.0ft	3.66m	2.7fc	6.6ft	2.01m	6.6ft	2.01m
15.0ft	4.57m	1.7fc	8.3ft	2.53m	8.2ft	2.50m
18.0ft	5.49m	1.2fc	9.9ft	3.02m	9.8ft	2.99m

■ Vertical Beam Spread: 30.8°
 ■ Horizontal Beam Spread: 29.9°

Polar Candela Distribution

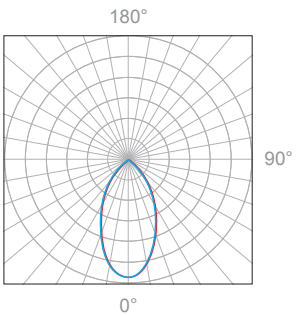

Beam Width: 45°

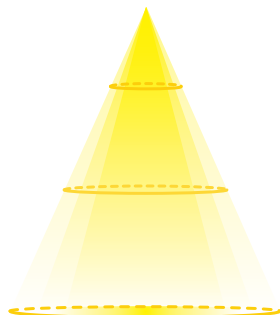

Illuminance at a Distance

Distance		Center Beam fc	Beam Width			
3.0ft	0.91m	13.2fc	2.6ft	0.79m	2.6ft	0.79m
6.0ft	1.83m	3.31fc	5.3ft	1.61m	5.2ft	1.58m
9.0ft	2.74m	1.47fc	7.9ft	2.40m	7.8ft	2.37m
12.0ft	3.66m	0.83fc	10.5ft	3.20m	10.5ft	3.20m
15.0ft	4.57m	0.53fc	13.2ft	4.02m	13.1ft	3.98m
18.0ft	5.49m	0.37fc	15.8ft	4.81m	15.7ft	4.78m

■ Vertical Beam Spread: 47.5°
 ■ Horizontal Beam Spread: 47.1°

2W, 3000K, 90+ CRI, Silver Reflector

Polar Candela Distribution

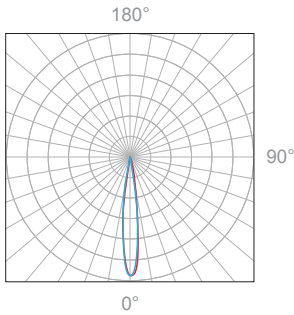

Beam Width: 12°



Illuminance at a Distance

Distance		Center Beam fc	Beam Width			
3.0ft	0.91m	96fc	2.1ft	0.64m	2.1ft	0.64m
6.0ft	1.83m	23fc	4.2ft	1.28m	4.2ft	1.28m
9.0ft	2.74m	10fc	6.3ft	1.92m	6.3ft	1.92m
12.0ft	3.66m	6fc	8.4ft	2.56m	8.4ft	2.56m
15.0ft	4.57m	3.6fc	10.5ft	3.20m	10.5ft	3.20m
18.0ft	5.49m	2.7fc	12.6ft	3.84m	12.6ft	3.84m

- Vertical Beam Spread : 38.6°
- Horizontal Beam Spread : 39.8°

Polar Candela Distribution

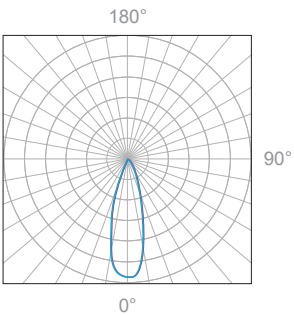

Beam Width: 30°

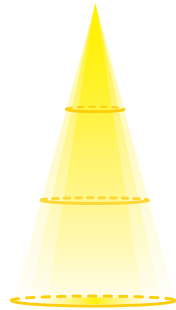

Illuminance at a Distance

Distance		Center Beam fc	Beam Width			
3.0ft	0.91m	77fc	3.7ft	1.12m	3.7ft	1.12m
6.0ft	1.83m	19fc	7.4ft	2.26m	7.4ft	2.26m
9.0ft	2.74m	8.6fc	11.1ft	3.83m	11.1ft	3.83m
12.0ft	3.66m	4.9fc	14.9ft	4.54m	14.9ft	4.54m
15.0ft	4.57m	3.2fc	18.6ft	5.67m	18.6ft	5.67m
18.0ft	5.49m	2.2fc	22.3ft	6.80m	22.3ft	6.80m

- Vertical Beam Spread : 63.5°
- Horizontal Beam Spread : 63.5°

Polar Candela Distribution

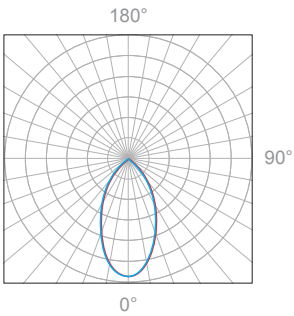

Beam Width: 45°

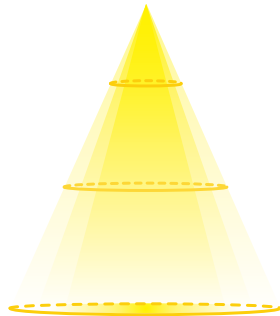

Illuminance at a Distance

Distance		Center Beam fc	Beam Width			
3.0ft	0.91m	13.2fc	2.6ft	0.79m	2.6ft	0.79m
6.0ft	1.83m	3.31fc	5.3ft	1.61m	5.3ft	1.61m
9.0ft	2.74m	1.47fc	7.9ft	2.40m	7.9ft	2.40m
12.0ft	3.66m	0.83fc	10.5ft	3.20m	10.5ft	3.20m
15.0ft	4.57m	0.53fc	13.2ft	4.02m	13.2ft	4.02m
18.0ft	5.49m	0.37fc	15.8ft	4.81m	15.8ft	4.81m

- Vertical Beam Spread: 47.4°
- Horizontal Beam Spread: 47.4°

Warm Dimming VS. Halogen

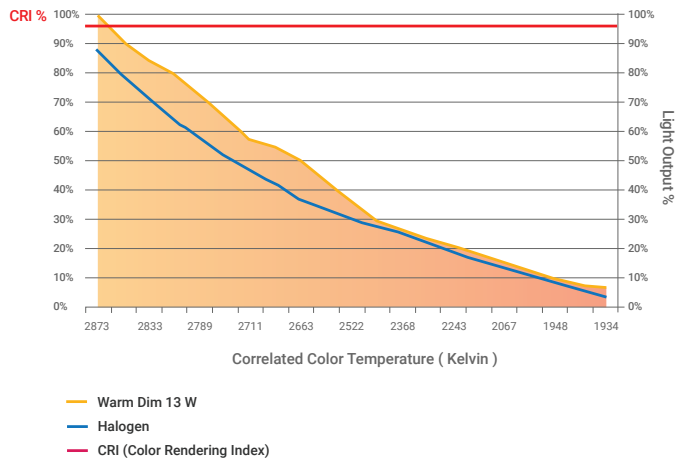

Full Spectrum

Full Spectrum Standard Illuminant @ 3000K Ra≥80

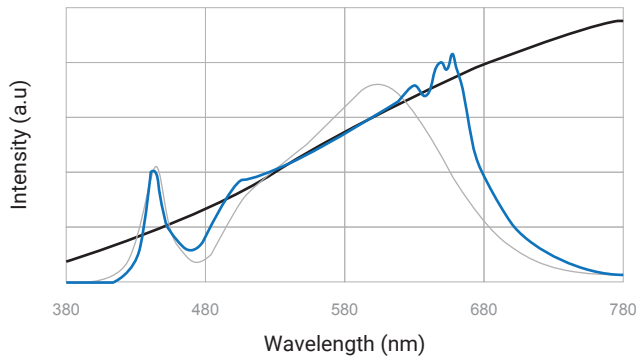

Appendix

Aluminum Finishes

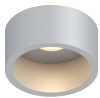

MA matte clear anodized



BA black anodized