

U302

LED Submersible / Swimming Pools

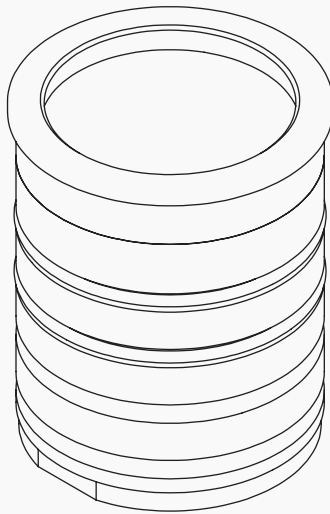

Standard Flange

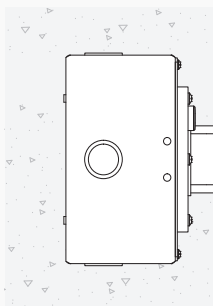

U302

LED Submersible / Swimming Pools

Parts

U302 Back Box
 LED trim x 1
 Waterproof leads
 Silicon grease — Included

- 1) Install wiring and conduit in fixture box.
- 2) Install conduit with string line in position between fixture box (below water line) and Junction box (above water line). **ELECTRICAL CONNECTION IS MADE ABOVE WATER LINE.** Failure to do this will cause fixture to fill with water and void warranty. Refer to applicable wiring diagram.
- 2) Ensure all gaskets are in place and knockouts are plugged. Take appropriate steps to support box from collapsing and prevent concrete from entering box during concrete pour.

DO NOT LET CONCRETE ENTER BOX.

- 3) Position electrical box so flange is within 1/4" (6mm) from top of poured concrete.
- 4) After concrete has cured, crack concrete above flange and remove plastic cap.

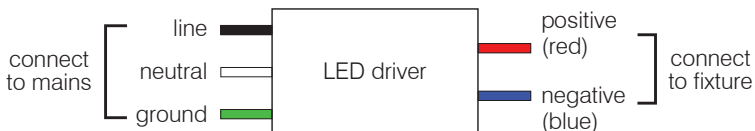
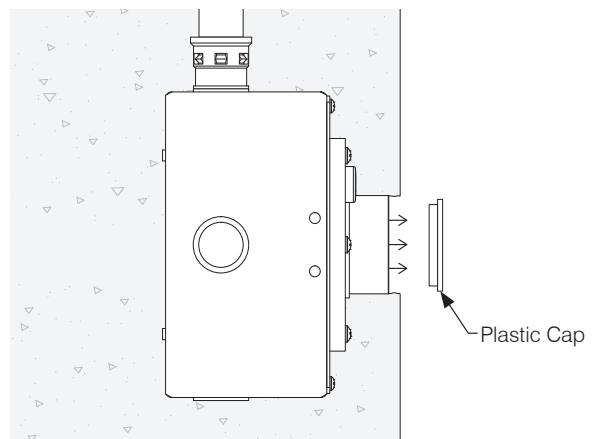
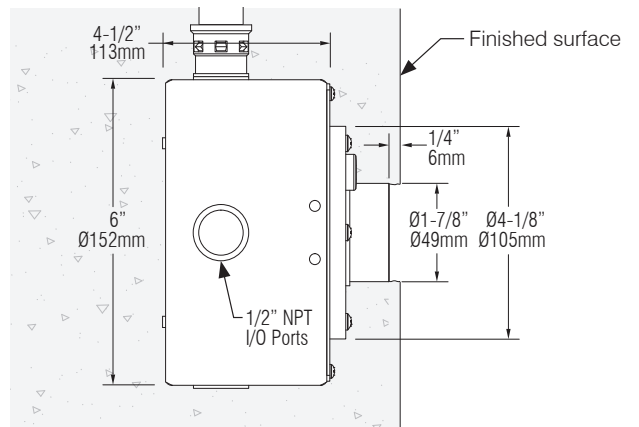
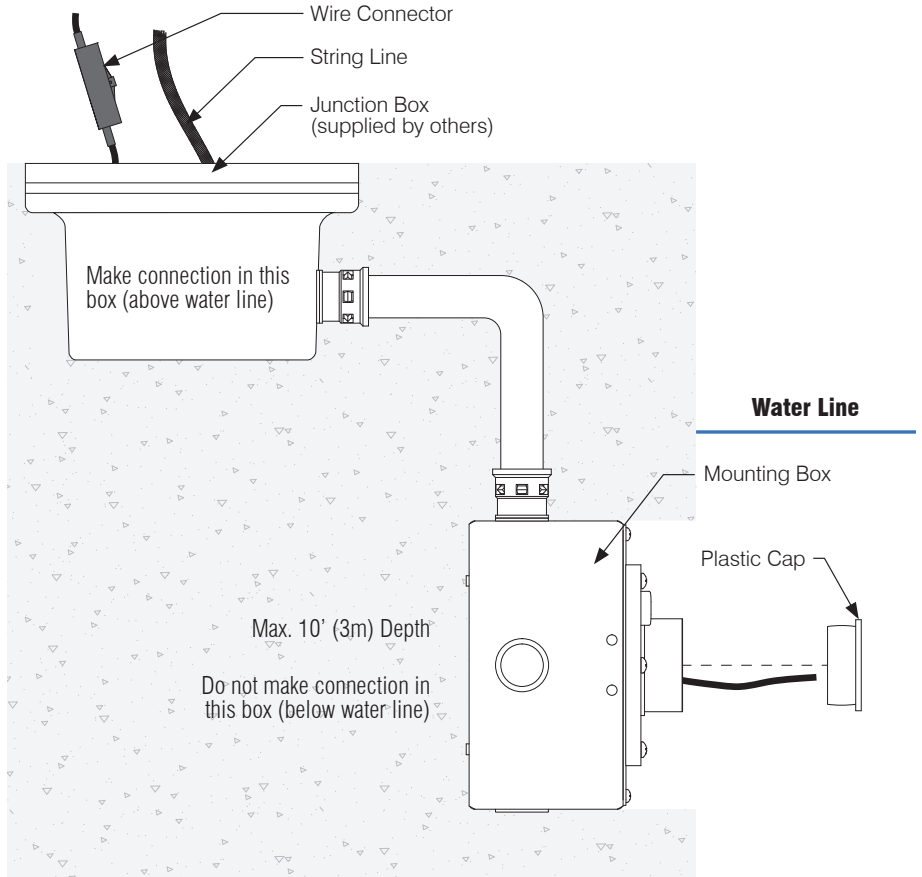

U302

LED Submersible / Swimming Pools

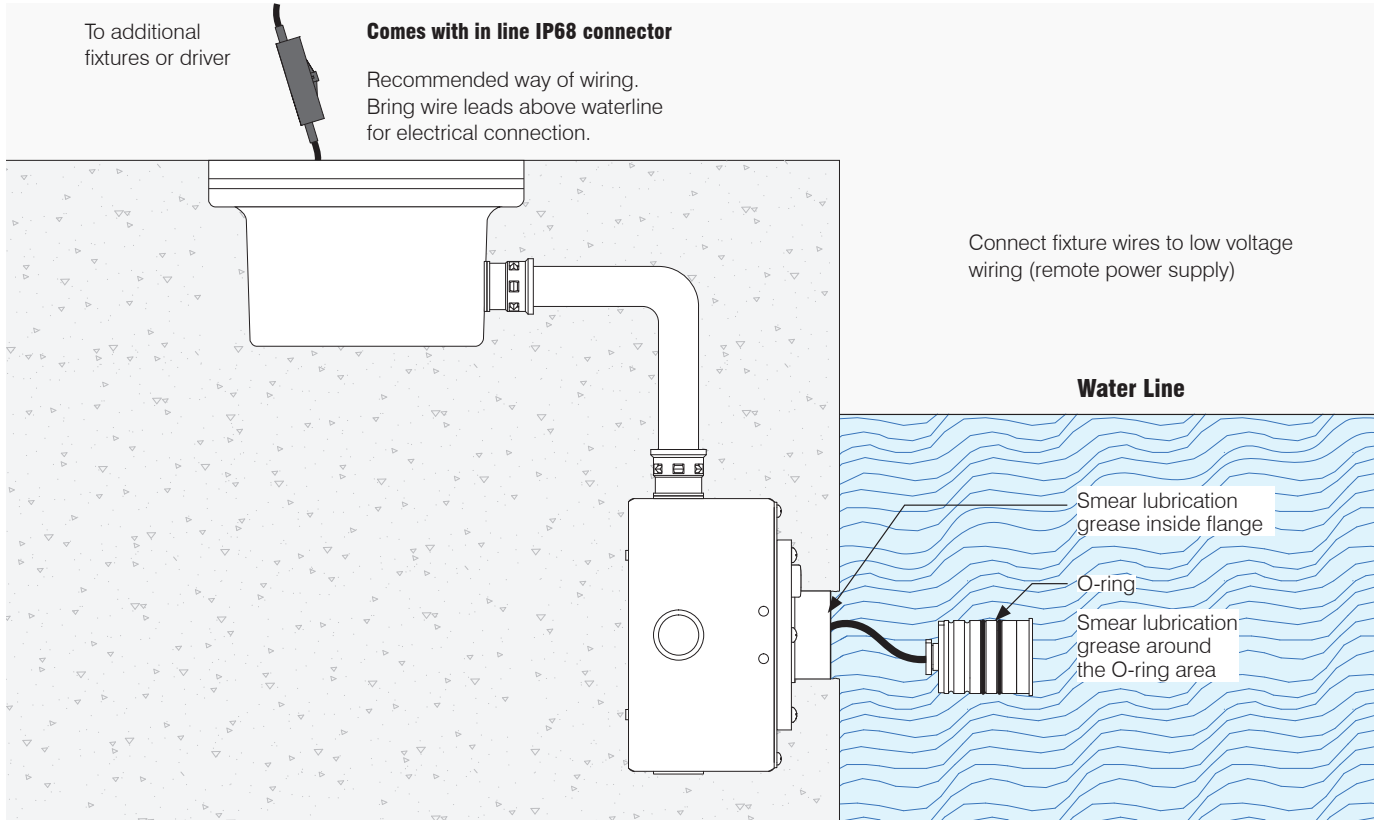
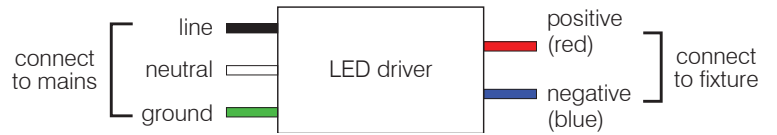

5) The power to the driver must be off while wiring LED fixtures to drivers. Feed waterproof fixture lead and pull through conduit to splice box. Connect fixture leads at Junction box, above the water line, according to applicable wiring diagram.

6) APPLY LUBRICATION GREASE to bottom of trim and inside of flange, for proper insertion and removal of trim.

With a twisting back and forth motion insert trim into flange.

*If fixture has an angle bracket, make sure beam is lined up in desired direction when inserting the trim.

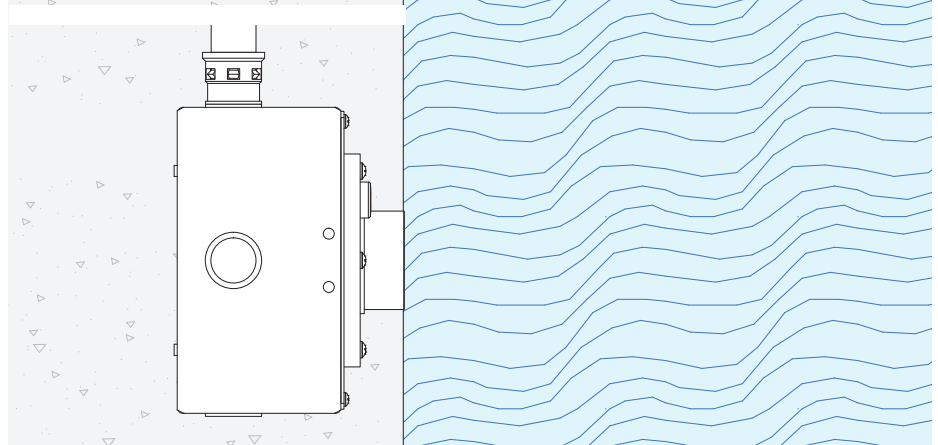
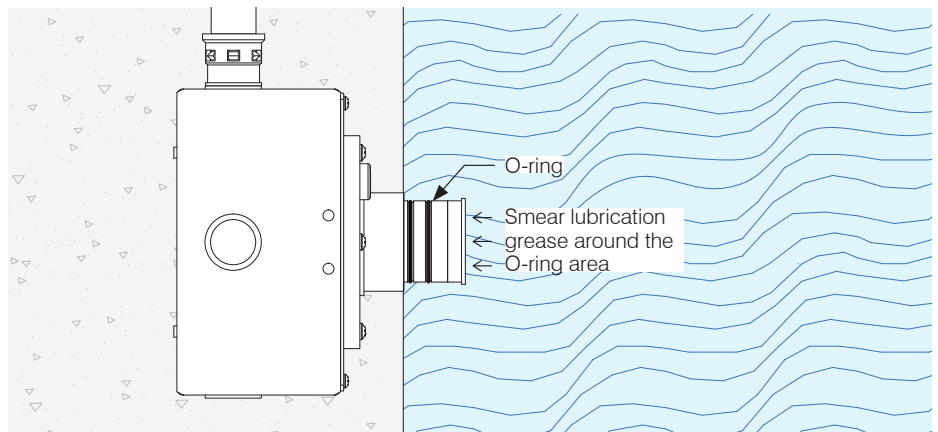



IMPORTANT SAFETY INSTRUCTIONS

KEEP THESE INSTALLATION INSTRUCTIONS

(Including General and Additional Markings for Fixtures)

General/additional markings for luminaires

1. MAXIMUM DEPTH 300 cm
2. CONNECT ONLY TO POWER SUPPLY INTENDED FOR USE WITH SUBMERSIBLE LUMINAIRES
3. FORMING SHELL No. [Catalogue Number]

General/additional markings for power supplies

4. FOR USE WITH SUBMERSIBLE LUMINAIRE
5. TEST GROUND FAULT CIRCUIT INTERRUPTER REGULARY
6. INSTALL ONLY ON A BRANCH CIRCUIT PROTECTED BY A CLASS A TYPE GROUND A FAULT CIRCUIT INTERRUPTER
7. DO NOT CONNECT TWO OR MORE POWER SUPPLIES IN PARALLEL
8. SUPPLY CONNECTION, USE ONLY AN ISOLATING LOW VOLTAGE POWER SUPPLY WITH UNGROUNDED OUTPUT, EVALUATED FOR SWIMMING POOL USE.

General/additional markings for junction boxes

9. SUITABLE FOR USE WITH AN EXTRA-LOW VOLTAGE SUBMERSIBLE LUMINAIRE
10. MAXIMUM DEPTH 300 cm

Installation instructions

11. WARNING: RISK OF FIRE OR ELECTRIC SHOCK: DO NOT MAKE OR ALTER ANY OPENINGS IN THE COMPARTMENT OF WIRING OR ELECTRICAL COMPONENTS DURING INSTALLATION. DO NOT ALTER OR ADD BALLASTS, OR ANY OTHER ELECTRICAL COMPONENTS.
12. INSTALLATION AND USE OF THIS FIXTURE MOUNTING ASSEMBLY REQUIRES A PERSON FAMILIAR WITH THE CONSTRUCTION AND OPERATION OF LUMINAIRE ELECTRICAL SYSTEMS AND THE HAZARD INVOLVED, IF NOT QUALIFIED, DO NOT ATTEMPT INSTALLATION. CONTACT A QUALIFIED ELECTRICIAN.
13. TURN OFF POWER BEFORE INSTALLATION.
14. KEEP THESE INSTALLATION INSTRUCTIONS.



CONSIGNES DE SÉCURITÉ IMPORTANTES

CONSERVER CES INSTRUCTIONS D'INSTALLATION

(Dont le général et marques supplémentaires pour les appareils)

Marquage général et additionnel des luminaires

1. PROFONDEUR MAXIMALE 300 cm
2. RACCORDER UNIQUEMENT À UNE ALIMENTATION CONVENANT À DES LUMINAIRES SUBMERSIBLES
3. COQUE À FORMER [référence au catalogue]

Marques générales et supplémentaires pour les alimentations

4. POUR LUMINAIRE SUBMERSIBLE
5. VÉRIFIER RÉGULIÈREMENT LE DISJONCTEUR DIFFÉRENTIEL
6. INSTALLER UNIQUEMENT DANS UNE DÉRIVATION PROTÉGÉE PAR UN DISJONCTEUR DIFFÉRENTIEL DE CLASSE A
7. NE PAS RACCORDER DEUX BLOCS D'ALIMENTATION, OU PLUS, EN PARALLÈLE
8. BRANCHEMENT D'ALIMENTATION, UTILISEZ UNIQUEMENT UNE ALIMENTATION ÉLECTRIQUE À BASE TENSION ISOLÉE AVEC SORTIE NON-MISE À LA TERRE, ÉVALUÉE POUR UTILISATION DANS UNE PISCINE.

Marques générales et supplémentaires pour les boîtes de jonction

9. CONVIENT À UN LUMINAIRE SUBMERSIBLE À TRÈS BASSE TENSION
10. PROFONDEUR MAXIMALE 300 cm

Les instructions d'installation

11. AVERTISSEMENT: RISQUE D'INCENDIE OU D'ÉLECTROCUTION: NE PAS FAIRE OU MODIFIER DES OUVERTURES DANS LE COMPARTIMENT DE CÂBLAGE OU DE COMPOSANTS ÉLECTRIQUES LORS DE L'INSTALLATION. NE PAS MODIFIER OU AJOUTER DES BALLASTS, OU AUTRES COMPOSANTS ÉLECTRIQUES
12. CE PRODUIT DOIT ÊTRE INSTALLÉ SELON LE CODE D'INSTALLATION PERTINENT, PAR UNE PERSONNE QUI CONNAÎT BIEN LE PRODUIT ET SON FONCTIONNEMENT AINSI QUE LES RISQUES INHÉRENTS. CONSULTER UN ÉLECTRICIEN QUALIFIÉ.
13. COUPER LE COURANT AVANT L'INSTALLATION.
14. CONSERVEZ CES INSTRUCTIONS.