

U366

UNDERWATER: CHLORINATED WATER & FRESH WATER
 In-grade | Submersed under water up to 10' (3m) depth.

- Underwater/Swimming Pool/Natatorium Certified

CSA - CLASS 3425 09 -Submersible

CSA - CLASS 3425 89 -Submersible - Certified to US Standards

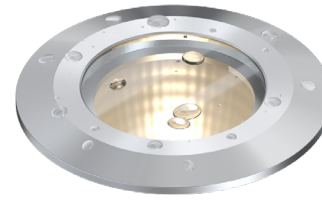

Ordering Information

Clear Form

Date : _____

Quantity : _____

Project : _____

Note : _____

Type : _____

Specifications

Luminaire | Example Code: U366-8-W30H-N-S-C-MK1-B-15-A-S6

Product	Version	CCT & CRI ¹	Beam Angle	Reflector Colour	Lens	Mounting Kit ² (optional)	Flange & Back Box	Lead Length ³	Input Voltage	Trim Finish
U366	8						B			
	8 8W	W27H 2700K 90+ W30H 3000K 90+	S spot 12° N narrow flood 30° F flood 60°	S silver B black	C clear F frosted	MK1 vertical surface	B back box	15 15' (4572mm) X custom	A 12V AC D 12V DC	Stainless Steel Finish: S6 stainless steel 316

System Components (Ordered Separately)

Pool-certified power supply : _____

* Consult MP Lighting Website or Factory.

Important Notes

Specification

1. Refer to pg.2 - for Colour Consistency details.
2. Mounting kit is ordered separately. Please consult factory.
3. Custom length available by 1' increments.

Warranty Notes & Disclaimer

Malfunction and damage to product due to incompatible dimming system or misuse will not be covered under warranty. Consult MP Lighting for recommended drivers. If the fixture has an option to be installed with a dimming control system, consult a dimming system manufacturer with minimum load before installing. MP Lighting reserves the right, at its sole discretion, at any time and without notice, to make design changes to any of our products. Consult MP Lighting website for most updated documentation.

U366

UNDERWATER: CHLORINATED WATER & FRESH WATER
 In-grade | Submersed under water up to 10' (3m) depth.

- Underwater/Swimming Pool/Natatorium Certified

CSA - CLASS 3425 09 -Submersible

CSA - CLASS 3425 89 -Submersible - Certified to US Standards

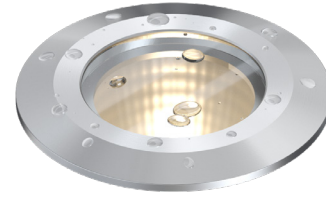

Performance

Wattage	Forward Current	Power Consumption Budget per fixture (including driver)	LED output (Source)	Fixture Output (Delivered)
8W	700mA	8.0W	880 lm	425-443 lm

Application

Environment	Underwater/ Wet/ Damp/ Dry Location approved. IP 68.
Mounting	Recessed: Designed to be cast into earth, gravel, or concrete for submersed applications. MK1 mounting kit (optional): Recommended for easy installation on vertical surfaces (e.g. stair risers, walls), and downward-facing surfaces (e.g. ceilings, soffits). See "Mounting Options & Dimensions, " or visit MK1

Electrical

Power Supplies	Compatible with remote pool-certified power supplies
Control	On/off control

Luminaire Construction

LED Light Source	W27H = CCT: 2700K, CRI (Ra): 90+, Colour Consistency: 2SDCM W30H = CCT: 3000K, CRI (Ra): 90+, Colour Consistency: 2SDCM
Weight	N/A
Material	Fixture: Stainless steel (316) with tempered glass
Supplied with	Standard installation housing: Comes with a 304 stainless steel square back box, an brass/stainless steel 316 flange, an integral leveling device, a plastic cap, and silicone grease. Wire lead: 15' (4572mm)
Warranty & LED Life	5 years limited warranty Estimated useful life of LED is 50,000 hours.

Ordered Separately

System Components	Power supplies: remote power supply Please consult factory or visit Recommended Drivers for available driver options. Mounting kits: MK1
-------------------	--

Mounting Options & Dimensions

LED Insert Dimensions

Fixture

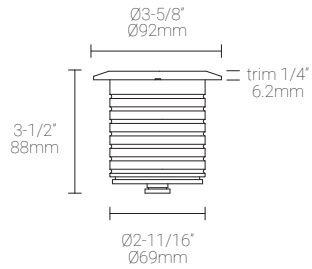

Top View

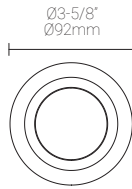

3D View

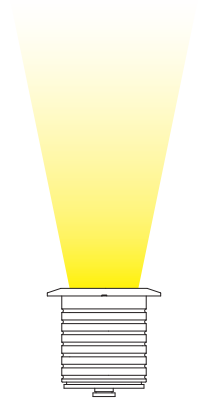

In-ground Installation (shown with MP Lighting Back Box | Order Code: EBX-SQR1-DSBR)

Box with Standard Flange

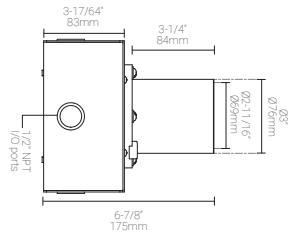

Box with Standard Flange:
During Concrete Installation

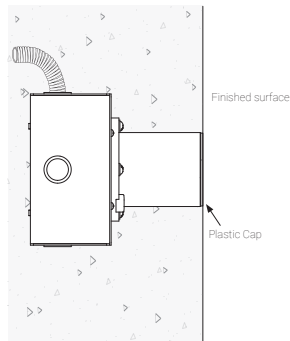

Box with Standard Flange:
During Concrete Installation

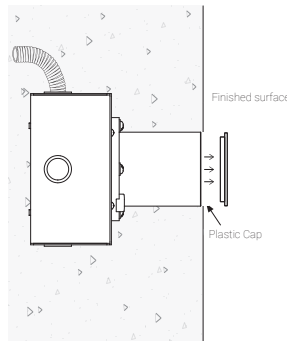

Box with Standard Flange:
Complete Concrete Installation

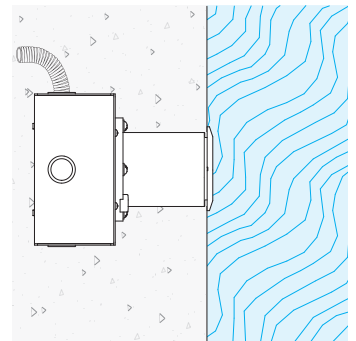

Mounting Kit

MK1: Ceiling, Wall, and Stair Riser Installation (shown with MP Lighting Back Box | Order Code: EBX-SQR1-DSBR)

Box with Standard Flange

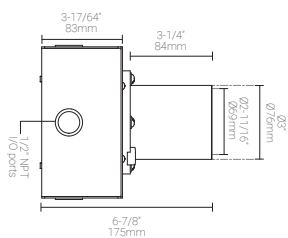

Box with Standard Flange & MK1:
During Installation

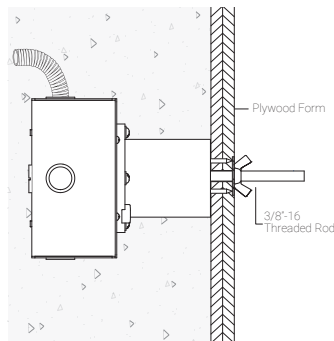

Box with Standard Flange:
Complete Installation

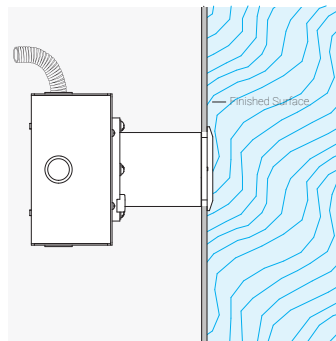

6" (152mm) threaded rod is supplied. Thread size: 3/8"-16

Polar Candela Distribution

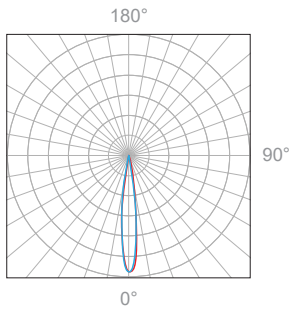

Beam Width: 12°



Illuminance at a Distance

Distance		Center Beam	Beam Width			
1.5ft	0.46m	4490fc	0.5ft	0.15m	0.5ft	0.15m
3.0ft	0.91m	998fc	1.0ft	0.30m	1.0ft	0.30m
4.5ft	1.37m	403fc	1.5ft	0.46m	1.5ft	0.46m
6.0ft	1.83m	223fc	2.0ft	0.61m	2.0ft	0.61m
7.5ft	2.29m	140fc	2.5ft	0.76m	2.5ft	0.76m
9.0ft	2.74m	97fc	3.1ft	0.94m	3.1ft	0.94m
12ft	3.66m	54fc	4.1ft	1.25m	4.1ft	1.25m
15ft	4.57m	34fc	5.1ft	1.55m	5.1ft	1.55m
18ft	5.49m	24fc	6.1ft	1.86m	6.1ft	1.86m

Delivered Lumen: 247.1lm
 ■ Vertical Beam Spread: 19.2°
 ■ Horizontal Beam Spread: 19.2°

Polar Candela Distribution

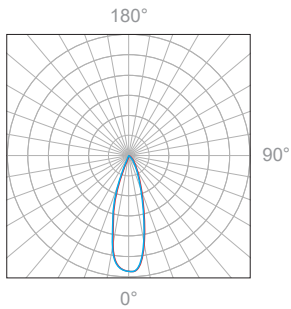

Beam Width: 30°

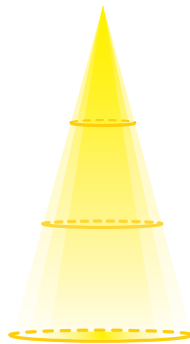

Illuminance at a Distance

Distance		Center Beam	Beam Width			
1.5ft	0.46m	706fc	0.8ft	0.24m	0.8ft	0.24m
3.0ft	0.91m	175fc	1.6ft	0.49m	1.6ft	0.49m
4.5ft	1.37m	76fc	2.4ft	0.73m	2.4ft	0.73m
6.0ft	1.83m	44fc	3.2ft	0.98m	3.2ft	0.98m
7.5ft	2.29m	28fc	3.9ft	1.19m	3.9ft	1.19m
9.0ft	2.74m	19fc	4.7ft	1.43m	4.7ft	1.43m
12ft	3.66m	11fc	6.3ft	1.92m	6.3ft	1.92m
15ft	4.57m	7.2fc	7.9ft	2.41m	7.9ft	2.41m
18ft	5.49m	5.1fc	9.5ft	2.90m	9.5ft	2.90m

Delivered Lumen: 275.5lm
 ■ Vertical Beam Spread: 29.5°
 ■ Horizontal Beam Spread: 29.5°

Polar Candela Distribution

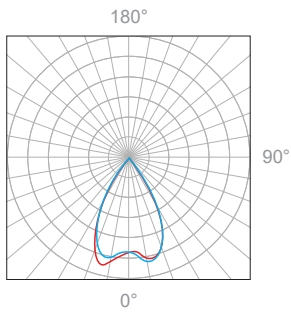

Beam Width: 60°

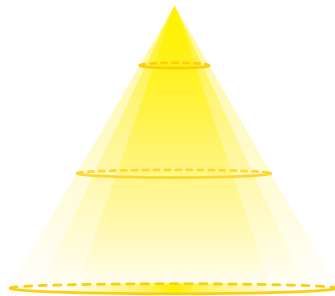

Illuminance at a Distance

Distance		Center Beam	Beam Width			
1.5ft	0.46m	267fc	1.7ft	0.52m	1.7ft	0.52m
3.0ft	0.91m	73fc	3.5ft	1.07m	3.5ft	1.07m
4.5ft	1.37m	32fc	5.2ft	1.58m	5.2ft	1.58m
6.0ft	1.83m	18fc	7.0ft	2.13m	7.0ft	2.13m
7.5ft	2.29m	12fc	8.7ft	2.65m	8.7ft	2.65m
9.0ft	2.74m	8.4fc	10.5ft	3.20m	10.5ft	3.20m
12ft	3.66m	4.8fc	14.0ft	4.27m	14.0ft	4.27m
15ft	4.57m	3.2fc	17.4ft	5.30m	17.4ft	5.30m
18ft	5.49m	2.3fc	20.9ft	6.37m	20.9ft	6.37m

Delivered Lumen: 189.4lm
 ■ Vertical Beam Spread : 60.4°
 ■ Horizontal Beam Spread : 60.4°

Appendix

Stainless Steel Finish



S6 stainless steel 316

Accessories

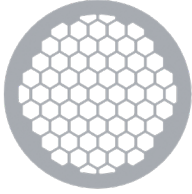

HM2 hex louver, matte clear anodized



HB2 hex louver, black anodized



AB2 angled louver, black anodized

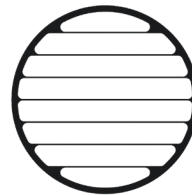

SB2 straight louver, black anodized

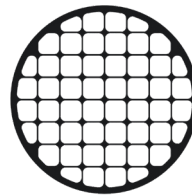

QB2 square louver, black anodized

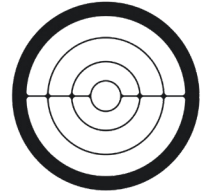

RB2 ring louver, black anodized

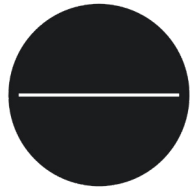

NB2 narrow beam louver, black